



Votre partenaire pour l'agencement
de l'habitat

Your partner for home improvement

Ihr partner für die gestaltung des lebensraums

Su socio para el acondicionamiento
de la vivienda

CATALOGUE
2021



www.nordlinger-pro.com



Plus de 80 ans d'expérience ont permis à la société Nordlinger Pro de devenir leader dans le domaine des bandes de chants et des solutions d'amélioration de l'habitat.

Vos administratrices des ventes



Hélène (OUEST)
+ 33 5 45 78 33 04
Pays Anglo-Saxons



Gaëlle
+ 33 5 45 78 79 71

Responsable administration des ventes



Bénédicte (EST)
+ 33 5 45 78 79 57
Export Sud Europe
ESPAGNE - PORTUGAL - ITALIE
+ Export reste du monde



La société Nordlinger Pro a fait certifier sa chaîne de contrôle FSC® sous le n° BV-COC-929012, nous sommes donc en mesure de vous fournir des produits labellisés sous la licence FSC C017221.
La société Nordlinger Pro a fait certifier sa chaîne de contrôle PEFC™ sous le n° BV/CDC/7163744, nous sommes donc en mesure de vous fournir des produits labellisés sous la licence PEFC/10-31-3387.

Seuls les produits portant ces symboles sont FSC® ou PEFC™ sont agréés selon les origines du bois certifié.



PANNEAUX | P6



Echantillons
Tableaux de correspondance
Formats et encollages disponibles
Bandes de chant
Placage bois
Revêtement adhésif
Profils plastiques
Araseurs de chant



CUISINE | P28



Bande de chant pour plan de travail
Profilés pour crédence et plan de travail
Étanchéité
Accessoires pour meubles et plinthes



Sol & Mur | P36



Système Ô Mur
Plaque Composite
Clips à lambris
Smart Profile
Nez de cloison
Plinthes cache'fil



ACCESSOIRES & OUTILLAGE | P41



Systèmes d'assemblage
Bande anti-dérapante
Tréteaux
Barrières pour animaux

SÉCURITÉ | P48



Barrières de sécurité enfants
Accessoires de sécurité domestique
Barrières de lit



AIDES À LA VENTE | P53

CONDITIONS GÉNÉRALES DE VENTE | P55

Les dimensions figurant dans ce catalogue sont indicatives et peuvent accepter de légères variations. Documents et photographies non contractuels.

The dimensions stated in this catalogue are for information only and are subject to slight variations. Documents and photographs are not contractual • Die Abmessungen in diesem Katalog sind unverbindlich und können geringfügige Abweichungen zu akzeptieren. Dokumente und Fotos sind nicht vertraglich • Las dimensiones de este catálogo son indicativas y pueden aceptar ligeras variaciones. Documentos y fotografías no contractuales

Pour tous les produits : Gencod = 3 35476 XXXXXX X (ref pdt)

H. Hauteur
Height • Höhe • Altura

l. Largeur
Width • Breite • Ancho

L. Longueur
Length • Länge • Longitud

Ep. Épaisseur
Thickness • Dicke • Espesor

UC. Unité de commande
Order unit • Bestelleinheit
Unidad de pedido



Sachet cavalier Plastic bag with header • Plastikbeutel mit Header
Bolsa de plástico con cabecera



Skin-pack ou blister
Skin Pack or blister • Skin Pack oder blister • Skin Pack o Blaster



Boîte
Box • Box • Caja



Fourreau
Sleeve • Schlauch • Tubo



Rouleau
Roll • Rolle • Rollo



Chant : film plastique Plastic film
Plastiktasche • Bolsa de plástico



Chant : vrac Bulk
Unverpackt • A granel



Barrière : film plastique
Plastic film • Plastiktasche
Bolsa de plástico



CONCEPTION

Une équipe « Recherche & Développement » de 5 personnes pour concevoir et mettre au point des solutions techniques innovantes, pour gagner en performance et faciliter la mise en œuvre.

A 5 person R & D team to design and develop innovative and technical solutions to improve performance and make implementation easier • Ein R & D Team von 5 Personen, das innovative technische Lösungen entwirft und entwickelt, um sie effizient und einfach zu implementieren • Un equipo de I + D de 5 personas para diseñar y desarrollar soluciones técnicas innovadoras para mejorar el rendimiento y facilitar su aplicación.



FABRICATION

Une parfaite maîtrise de la chaîne de fabrication grâce à une expertise industrielle de 60 ans.

Perfect control of the production line thanks to an industrial expertise of more than 60 years • Eine perfekt kontrollierte Produktionslinie dank eines industriellen Know-hows von mehr als 60 Jahren • Perfecto control de la línea de producción gracias a una experiencia industrial de más de 60 años.



LOGISTIQUE

Une logistique dédiée à nos clients dont l'excellence est reconnue depuis plus de 30 ans.

Dedicated logistics to customers whose excellence has been recognized for over 30 years • Spezielle Kundenlogistik, deren Exzellenz seit über 30 Jahren anerkannt ist • Logística dedicada a los clientes cuya excelencia ha sido reconocida por más de 30 años.

NORMES

Nos produits sont conçus, fabriqués et contrôlés dans un total respect des normes et exigences en vigueur selon un cahier des charges très strict répondant aux exigences des professionnels.

Our products are designed, manufactured and tested in full compliance with current standards according to strict specifications that meet the requirements of the trade • Unsere Produkte sind in voller Übereinstimmung mit den geltenden Normen entwickelt, gefertigt und geprüft, und unterliegen strengen Vorgaben, die den Anforderungen von Profis entsprechen • Nuestros productos están diseñados, fabricados y probados en plena conformidad con las normas vigentes y conforme a normativas estrictas que cumplan los requisitos de los profesionales.



MARKETING

Une approche marketing au service de votre stratégie :

- des gammes efficaces vous garantissant une couverture optimale de vos marchés,
- des services et des outils d'aide à la vente dédiés pour dynamiser vos ventes,
- une compétitivité de tous les instants.

A marketing approach to serve your strategy : effective ranges guaranteeing optimal coverage of your markets - dedicated services to boost your sales - competitiveness at all times • Ein Marketing-Ansatz, um Ihre Strategie zu unterstützen: effektive Kollektionen, die eine optimale Abdeckung Ihrer Märkte garantieren - spezielle Dienstleistungen, um Ihren Umsatz zu steigern - Wettbewerbsfähigkeit zu jeder Zeit • Un enfoque de marketing al servicio de su estrategia: colecciones eficaces para garantizar una cobertura óptima de sus mercados - servicios dedicados para aumentar sus ventas - competitividad en todo momento.

À VOTRE ÉCOUTE

Une organisation commerciale de 11 personnes à l'écoute de vos besoins et à vos côtés pour accélérer votre développement.

A commercial team of 11 people listening to your needs and by your side to accelerate your development • Ein kommerzielles Team von 11 Personen hört auf Ihre Bedürfnisse und beschleunigt an Ihrer Seite Ihre Entwicklung • Una organización comercial de 11 personas escuchando sus necesidades y a su lado para acelerar su desarrollo.





POLYREY
 KRONOSPAN FINSA RESOPAL
 THERMOPAL FORMICA KRONO
 PFLÉDERER
 FINSA FORMICA WODEGO
 EGGER KRONOSWISS RESOPAL
 WODEGO UNILIN RESOPAL
 KRONOFRANCE

BANDES de chant

PVC / ABS

BY One

Les couleurs du négoce

Des **concordances parfaites** avec les **plus grandes marques** de panneaux.

Consultez le module de recherche en ligne, **simple, rapide** et **accessible à tout moment**.



1000 DÉCORS AU CHOIX la flexibilité en plus !

- ✓ Offres quantitatives
- ✓ Nuancier décors sur demande
- ✓ Module de recherche de concordances en ligne <https://finder.nordlinger.pro.com>



Une gamme complète, composée de 1000 décors au choix.



Prestation encollage possible sur simple demande.



Différentes largeurs sont proposées, jusqu'à 66 mm.



Bandes de chant disponibles en différentes épaisseurs (0,45 mm, 1 mm, 2 mm).



Prestation découpe possible.



Option Airtech et Lasertech sur demande, avec délai supplémentaire.



Tarif unique livraison.

NORDEX

BLANC

- ✓ Existe aussi en pré encollé



Bandes de chant disponibles en différentes épaisseurs (de 0,45 mm à 2 mm).



Différentes largeurs sont proposées, jusqu'à 45 mm.

Ep.	2 mm	0,8 mm	0,6 mm	0,45 mm	0,8 mm	0,6 mm	0,8 mm	2 mm	0,8 mm	0,8 mm	
ℓ	23 mm				16 mm	26 mm			33 mm	45 mm	
L.	100 ml										
n° décors	Surface	Ref Pdt									
0 13265	Lisse	011563 2	010052 2	011415 4	011406 2	010176 5	010109 3	010117 8	011605 9	010241 0	010243 4
0 13265	Grainé	011635 6	010053 9	011444 4	011286 0	-	010108 6	010118 5	010021 8	010242 7	010244 1



1^{ère} bande de chant PVC adhésive

BANDE DE CHANT PVC ADHÉSIVE		
Ep.	0,8 mm	
ℓ	16 mm	19 mm
L.	5 ml	
Surface	Ref Pdt	
Lisse	030000 7	030001 4



Bandes de chant

Edgings - Kantenumleimer - Cantos



Guide d'utilisation des chants Nordlinger Pro

- 1/ Avec mon décor panneau
- 2/ J'évalue le décor chant Nordlinger correspondant
- 3/ Je vais à la page indiquée pour retrouver les formats et encollages disponibles

UNIS



Réf. S0869 / Page. 19



Réf. S5021 / Pages. 20, 24



Réf. S0843 / Page. 19



Réf. S5236 / Page. 22



Réf. S5159 / Page. 21



Réf. S0884 / Page. 20



Réf. S5220 / Page. 21



Réf. S5155 / Page. 21



Réf. S5195 / Page. 21



Réf. S0841 / Page. 19



Réf. S5196 / Page. 21



Réf. S0946 / Page. 20



Réf. S5252 / Page. 22



Réf. S5254 / Page. 22



Réf. S5253 / Page. 22



Réf. S5198 / Page. 21



Réf. S0874 / Page. 19



Réf. W1600 / Page. 22



Réf. I491 / Page. 19



Réf. S5163 / Page. 21



Réf. S5222 / Page. 21



Réf. S0769 / Page. 19



Réf. S0961 / Page. 20



Réf. S5245 / Page. 22



Réf. S0785 / Page. 19



Réf. S0960 / Page. 20



Réf. S0763 / Page. 19



Réf. S5242 / Page. 22



Réf. S0875 / Page. 20



Réf. S5029 / Page. 20



Réf. S5216 / Page. 21



Réf. S5209 / Page. 22



UNIS



Réf. S5165 / Page. 21



Réf. S5241 / Page. 22



Réf. S0755 / Page. 19

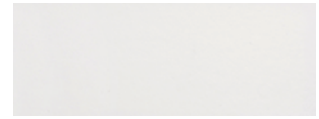

Réf. P099 / Pages. 19, 24, 28

PASTEL



Réf. S5251 / Page. 22



Réf. S5160 / Page. 21



Réf. S5154 / Page. 21



Réf. S0893 / Page. 20



Réf. S5162 / Page. 21



Réf. P104 / Pages. 19, 28



Réf. S5244 / Page. 22



Réf. S0815 / Page. 19



Réf. S5148 / Page. 21



Réf. S5219 / Page. 21



Réf. S5110 / Page. 20

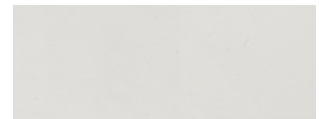

Réf. P150 / Pages. 19, 24, 28

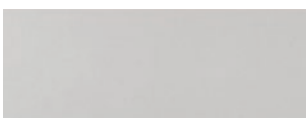

Réf. P121 / Pages. 19, 24



Réf. S0813 / Page. 19

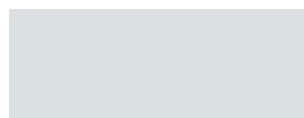

Réf. S5192 / Page. 21

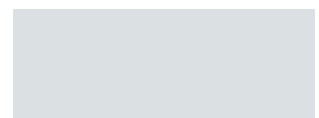

Réf. S5111 / Page. 20

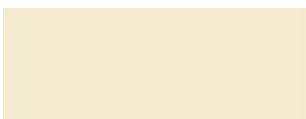

Réf. S0866 / Page. 19

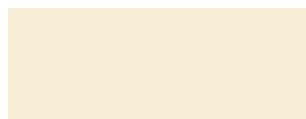

Réf. S0947 / Page. 20

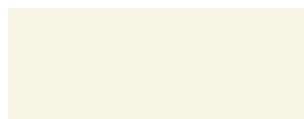

Réf. S5208 / Page. 21

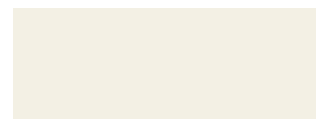

Réf. S5235 / Page. 22

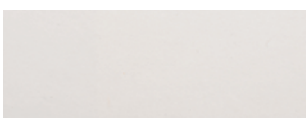

Réf. L001 / Page. 19

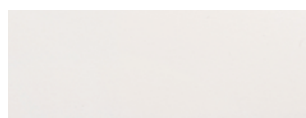

Réf. S5022 / Page. 20

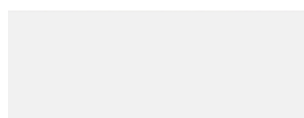

Réf. P268 / Page. 19

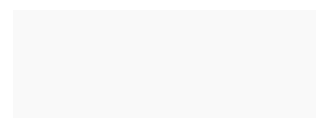

Réf. S0840 / Page. 19, 28

TEXTILE



Réf. S5108 / Page. 20, 28



Réf. S5248 / Page. 22

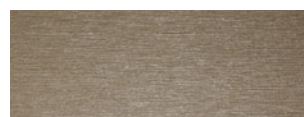

Réf. S5240 / Page. 22



Réf. S5109 / Page. 20

MÉTAL / MINÉRAL

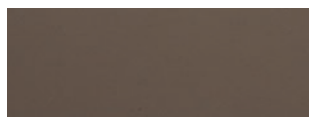

Réf. S5182 / Page. 21

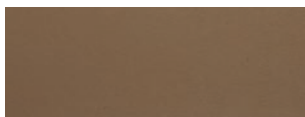

Réf. W1601 / Page. 24



Réf. SB3 / Page. 22



Réf. S5137 / Page. 20



Réf. I446 / Page. 19



Réf. I267 / Page. 19



Réf. P1000 / Page. 19

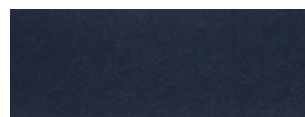

Réf. I1006 / Page. 19

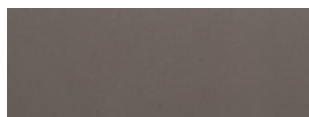

Réf. S0845 / Page. 19



Réf. S5247 / Page. 22



Réf. S5146 / Page. 21



Réf. F5002 / Page. 19



Réf. I264 / Pages. 19, 28



Réf. F5021 / Page. 28



Réf. I296 / Page. 19



Réf. S5217 / Page. 21



Réf. S5142 / Page. 21



Réf. F408 / Page. 28

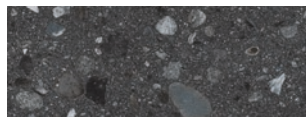

Réf. S5197 / Page. 21



Réf. S5250 / Page. 22



Réf. F5020 / Page. 19

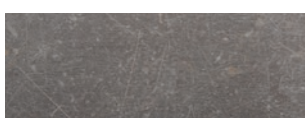

Réf. S5145 / Page. 21

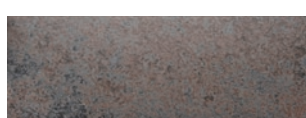

Réf. S5188 / Page. 28

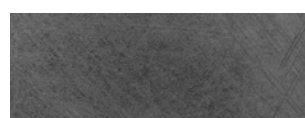

Réf. S5140 / Pages. 20, 28



Réf. W5020 / Page. 23



Réf. S0895 / Page. 20



Réf. W5028 / Page. 23

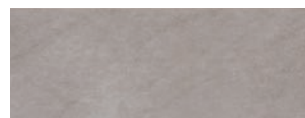

Réf. F5003 / Pages. 19, 24



Réf. W1597 / Pages. 23, 24

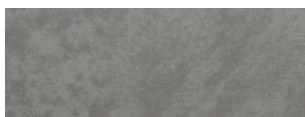

Réf. F5000 / Page. 19

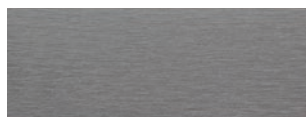

Réf. S5187 / Page. 22



Réf. P1001 / Page. 19



Réf. I442 / Pages. 19, 28



Réf. S5147 / Page. 21



Réf. S5138 / Pages. 20, 24, 28

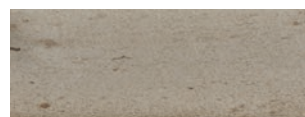

Réf. S5189 / Page. 28



MÉTAL / MINÉRAL



Réf. I1004 / Page. 19



Réf. S5183 / Pages. 21, 28



Réf. S5141 / Page. 21

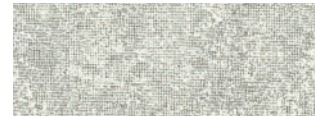

Réf. S5221 / Page. 21



Réf. S5226 / Page. 21



Réf. S0812 / Page. 19



Réf. W5034 / Page. 23

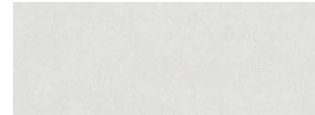

Réf. S5143 / Page. 21



Réf. P119 / Pages. 19

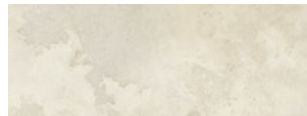

Réf. S5191 / Page. 21

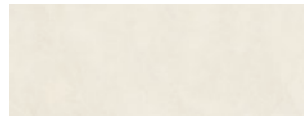

Réf. S5246 / Page. 22

BOIS CLAIR



Réf. S5218 / Page. 21



Réf. W5012 / Page. 23



Réf. S5201 / Page. 21



Réf. S5212 / Page. 21

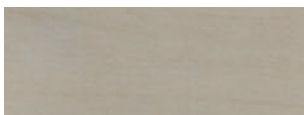

Réf. S0886 / Page. 20

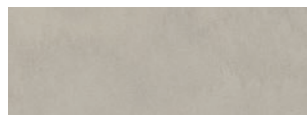

Réf. S5233 / Page. 23



Réf. S5199 / Page. 21



Réf. S5214 / Page. 21



Réf. W5027 / Page. 23



Réf. S5205 / Page. 21



Réf. S5255 / Page. 22



Réf. W5010 / Page. 23



Réf. S5237 / Page. 22



Réf. S5194 / Page. 21



Réf. S0877 / Page. 20



Réf. S5234 / Page. 22



Réf. S5215 / Page. 21



Réf. S0914 / Page. 20



Réf. S5135 / Page. 20



Réf. W1856 / Page. 23



Bandes de chant

Edgings - Kantenumleimer - Cantos

BOIS CLAIR



Réf. W5018 / Page. 23



Réf. S5257 / Page. 22



Réf. S0775 / Page. 19



Réf. S5127 / Page. 20



Réf. W5022 / Page. 23



Réf. S5131 / Pages. 20, 28



Réf. W080 / Page. 22



Réf. S5224 / Page. 21



Réf. S5037 / Pages. 20, 28



Réf. S5121 / Page. 20



Réf. W937 / Page. 22



Réf. W5023 / Page. 23



Réf. S0868 / Page. 19

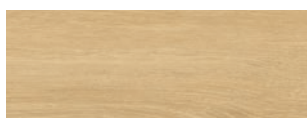

Réf. S5118 / Page. 20



Réf. S5125 / Page. 20



Réf. W108 / Page. 22



Réf. W5030 / Page. 23



Réf. W706 / Page. 22



Réf. S5122 / Page. 20

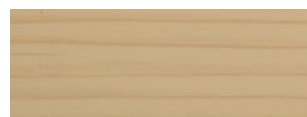

Réf. W602 / Page. 22



Réf. S5115 / Page. 20

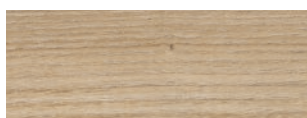

Réf. S5130 / Page. 20



Réf. S5117 / Page. 20



Réf. S5134 / Page. 20



Réf. W1421 / Pages. 22, 28



Réf. S5124 / Page. 20



Réf. S5113 / Page. 20



Réf. S5204 / Page. 21



Réf. S5227 / Page. 21



Réf. S0867 / Page. 19



Réf. S0842 / Page. 19



Réf. S5238 / Page. 22



Réf. S5213 / Page. 21

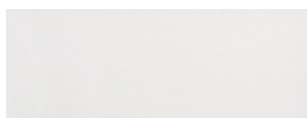

Réf. P099 / Pages. 19, 24, 28



Réf. S5171 / Page. 21



Réf. S5193 / Page. 21



BOIS FONCÉ



Réf. W014 / Page. 22



Réf. W522 / Pages. 22, 28



Réf. W933 / Page. 22



Réf. S5128 / Page. 20



Réf. W561 / Page. 22



Réf. W611 / Page. 22



Réf. W992 / Page. 22



Réf. W542 / Page. 22



Réf. W495 / Pages. 22, 28



Réf. W897 / Page. 22



Réf. W211 / Page. 22



Réf. W593 / Pages. 22, 28



Réf. S5225 / Page. 21



Réf. W5021 / Page. 23

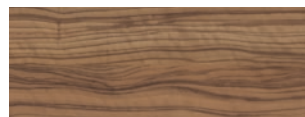

Réf. S5232 / Page. 22



Réf. S5207 / Page. 21



Réf. W5005 / Page. 23



Réf. S5129 / Page. 20



Réf. S5133 / Page. 20



Réf. S5202 / Page. 21



Réf. S5181 / Page. 21



Réf. W5019 / Page. 23



Réf. W5000 / Page. 23



Réf. S5107 / Pages. 20, 24, 28



Réf. W5013 / Page. 23

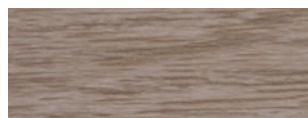

Réf. W5029 / Pages. 23, 24



Réf. S5132 / Page. 20



Réf. S0804 / Pages. 19, 24, 28



Réf. W5011 / Pages. 23, 24



Réf. S0898 / Page. 20



Réf. S0765 / Page. 19



Réf. W316 / Page. 22



Réf. S0803 / Page. 19

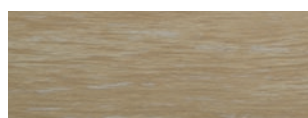

Réf. W1634 / Page. 22, 24, 28



Réf. S0756 / Page. 19

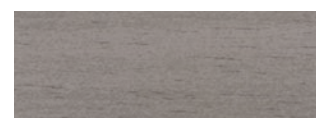

Réf. W1857 / Page. 23



Bandes de chant

Edgings - Kantenumleimer - Cantos

BOIS FONCÉ



Réf. W5036 / Page. 23



Réf. S5123 / Page. 20

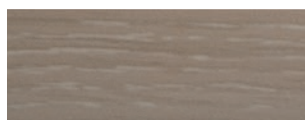

Réf. W1635 / Page. 23

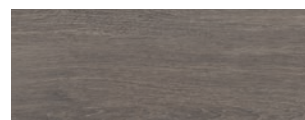

Réf. S5200 / Page. 21

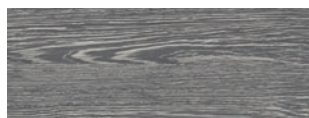

Réf. S5256 / Page. 22



Réf. S5120 / Pages. 20, 28



Réf. S5136 / Page. 20



Réf. W1855 / Pages. 23, 24



Réf. S5239 / Page. 22



Réf. S5243 / Page. 22



Réf. S0757 / Page. 19



Réf. S5203 / Page. 21



Réf. S5230 / Page. 22

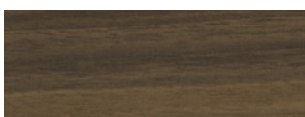

Réf. S5229 / Page. 22



Réf. S5231 / Page. 22

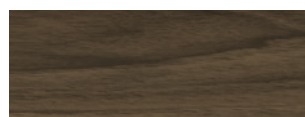

Réf. S5228 / Page. 21



Réf. S5206 / Page. 21



Réf. S5034 / Page. 20

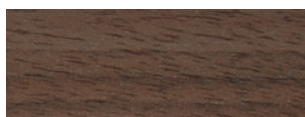

Réf. S0773 / Pages. 19, 24



Réf. S0935 / Page. 20



Réf. S0954 / Page. 20

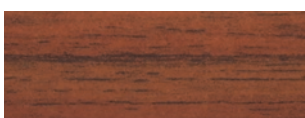

Réf. W1637 / Page. 23

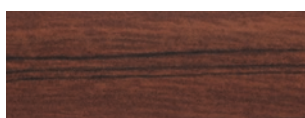

Réf. W1638 / Page. 23



Réf. W020 / Pages. 22, 28

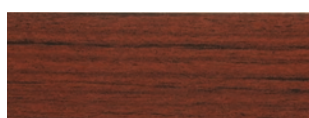

Réf. W013 / Page. 22



Réf. S0880 / Page. 20

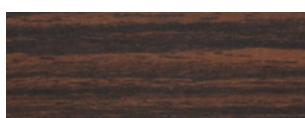

Réf. W1427 / Page. 22



Réf. S0764 / Page. 19



Réf. S5211 / Page. 21



Réf. W5026 / Page. 23

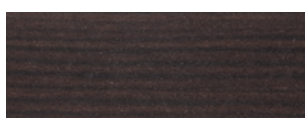

Réf. W1572 / Pages. 22, 28

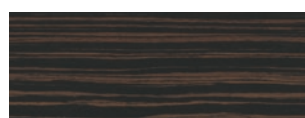

Réf. S5210 / Page. 21

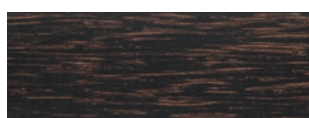

Réf. S5172 / Page. 21



Réf. S0761 / Page. 19

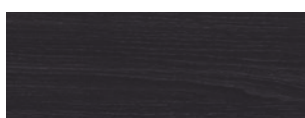

Réf. S5119 / Page. 20



Réf. S5112 / Page. 20

Bandes de chant mélaminées et CPL



Melamin und CPL Kantenumleimer • Melamine and CPL edgings • Cantos y CPL Melamínicos

Correspondances POLYREY

Panneaux POLYREY		Pré-encollé I, 23mm L 25mL	Non Encollé I, 23mm L 150mL
0005	NOIR CLASSIQUE	121293	130130
0030	BLANCO ESPECIAL	121275	130112
0149	GRIS PALOMA	121600	130411
0156	CREME CLASSIQUE	121290	130127
A094	ANTILOPE	121899	130552
A103	ARGILE SABLÉE	121628	130439
A120	ARACENA	121891	130544
B001	BLEU FLASH	121344	130181
B015	BLANC MENUIRES	121275	130112
B023	BOIS DE PÉCAN	121349	130188
B031	BORNEO NATUREL	121602	130413
B048	BLEU OSLO	121309	130146
B068	BLANC CHAMONIX	121275	130112
B069	BLANC COURCHEVEL	121282	130119
B070	BLANC MEGÈVE	121275	130112
B086	BLEU CARAÏBES	121283	130120
B092	BROSSE GRIS	121311	130148
B099	BRUSHED METAL	121631	130442
B100	BANIAN BLANCHI	121236	130073
B101	BANIAN NOIRCI	121241	130078
B116	BEIGE NATURE	121641	130452
B117	BLANC ARTIC	121282	130119
B124	BLEU BATIK	121892	130545
B131	BOULEAU ARGENTE	121603	130414
B134	BÉTON GRIFFE	121629	130440
B192	BOULEAU STEVENSON	121893	130546
B193	BOULEAU DE GASPÉSIE	121894	130547
B196	BLEU VELVET	121895	130548
B198	BLUE NOTE	121896	130549
B199	BETON CALADE	121897	130550
C003	CHÈNE DE MACÉDOINE	121607	130418
C017	COQUILLE D'ŒUF	121290	130127
C047	CHÈNE WENGÉ	121339	130176
C049	CACTUS	121898	130551
C062	CAPUCINE	121243	130080
C091	CHÈNE DE FIL BRUN	121339	130176
C098	CHÈNE DE FIL NATUREL	121291	130128
C101	CHÈNE BRUN HORIZONTAL	121244	130081
C102	CHÈNE CLAIR HORIZONTAL	121245	130082
C103	CHÈNE LAVE	121284	130121
C104	CŒUR DE POMMIER	121613	130424
C105	CHÈNE QUEBEC	121457	130302
C116	CHOCOLAT	121648	130459
C118	CÈDRE BLEU	121647	130458
C123	CHÈNE DE GUÉRANDÉ	121900	130553
C126	CHÈNE ANTIQUE	121901	130554
C127	CHÈNE GIVERNY	121609	130420
C128	CHÈNE ALASKA	121664	130475
C129	CHÈNE BASTIDE	121625	130436
C130	CHÈNE TOPIA	121611	130422
C131	CHÈNE MURANO	121610	130421
C132	CHÈNE DES MARAIS	121608	130419
C133	CHÈNE VENDOME	121612	130423
C134	CHÈNE BROCANTE	121608	130419
C135	CURMARU CLAIR HORIZON	121902	130555
C137	CHÈNE CUT NATUREL	121605	130416
C148	CHÈNE PYLA	121903	130556
C149	CHÈNE COLORADO	121904	130557
C150	CHÈNE BRASERO	121905	130558
C178	CHÂTAIGNER CORTE	121906	130559
C179	CHÈNE DES MASSIFS	121907	130560
C180	CHÈNE ALBA	121908	130561
C181	CERISIER NATUREL	121909	130562
C182	CHÈNE ADRIAN	121910	130563
C183	CHÈNE D'ARGENT	121911	130564
C184	CERISIER DES CARIATIDES	121912	130565
C185	CHÈNE D'AUSTRALIE	121913	130566
C186	CHÈNE DES COMBRAILLES	121914	130567
C187	CERISIER AMBRÉ	121915	130568
C188	CRÈME DE LAIT	121916	130569
C189	CYCLAMEN	121917	130570
D018	CHÈNE DE MEYMAC	121292	130129
D021	POMMIER DE DEAUVILLE	121307	130144
E009	ÉRABLE BLANC	121268	130105

Bandes de chant mélaminées et CPL



Melamin und CPL Kantenumleimer • Melamine and CPL edgings • Cantos y CPL Melamínicos

Correspondances POLYREY

Panneaux POLYREY		Pré-encollé I, 23mm L 25mL	Non Encollé I, 23mm L 150mL
E021	ÉCRU	121345	130182
E025	ÉRABLE WENGÉ	121237	130074
E028	ÉRABLE NORDIQUE	121314	130151
E035	ÉBÈNE	121918	130571
E042	ÉBÈNE ORANGA	121919	130572
E083	ÉLINA CLAIR	121920	130573
E103	Érable FÉROÉ	121921	130574
E104	ÉRABLE FÉROÉ HORIZONTAL	121922	130575
E105	ÉRABLE BRUNSWICK	121923	130576
F001	FLORIDA	121355	130194
F006	FER	121305	130142
F012	FRUITIER CENDRE	121269	130106
F026	FEUTRE	121278	130115
F055	FIGUE	121924	130577
F056	FRÈNE SCANDINAVE	121626	130437
F058	FRÈNE CRISTAL	121614	130425
F059	FRÈNE FONTE	121925	130578
F061	FRÈNE MONRÉALE	121626	130437
F098	FRÈNE BLOND	121926	130579
F099	FRÈNE CHARBONNÉ	121927	130580
G003	GRIS PERLE	121316	130153
G012	GRÈS	121235	130072
G024	GRENADE	121459	130293
G029	GRIS TOURTERELLE	121601	130412
G031	GENET	121356	130195
G044	GRIS DAUPHIN	121276	130113
G059	GRIS ORAGE	121285	130122
G075	GRIS CENDRE	121653	130464
G076	GRIS ACIER	121652	130463
G077	GALET	121928	130581
G082	GLACIS CHARBON	121929	130582
G119	GRIS DE LIN	121930	130583
G120	GRIS VISON	121931	130584
G122	GRID	121932	130585
H025	POMMIER DE HONFLEUR	121318	130155
H027	HÊTRE DE PROVENCE	121616	130427
H028	HÊTRE BERGEN	121615	130426
H029	HÊTRE STOCKHOLM	121618	130429
J018	JAUNE GOUACHE	121249	130086
J024	JAUNE SAMBRA	121933	130586
M001	MARYLAND CLAIR	121632	130443
M003	MARYLAND FONCE	121633	130444
M007	MERISIER RUSTIQUE	121619	130430
M091	MERISIER AMBRE	121319	130156
M100	MUSCADE	121655	130466
M103	MIMOSA	121655	130587
M106	MOSAÏC BLANC	121634	130445
M122	MULTIPLIS NATURE	121935	130588
M132	MULTIPLIS TROPICAL	121936	130589
M134	MARBRE SIROCO	121937	130590
N002	NÉON	121656	130467
N005	NOIR	121293	130130
N010	NOYER PERLE	121333	130170
N024	NOYER TROPICAL	121454	130299
N026	NOYER OMBRE	121253	130090
N056	NOISETIER NATUREL	121621	130432
N057	NOISETIER BRUN	121620	130431
N112	NOYER D'AMÉRIQUE	121938	130591
N113	NOYER MARBOT	121939	130592
N114	NOYER HAVANA	121940	130593
N115	NOYER HAVANA HORIZONTAL	121941	130594
N116	NOYER FLAMMÉ	121942	130595
N117	NOYER CHESTERFIELD	121943	130596
N118	NOYER APPALACHES	121944	130597
O030	OLIVIER DE SEVILLE	121255	130092
O076	OLIVIER FONCE/OLI.WO	121945	130598
O078	ORME DE NANCY	121624	130435
O079	ORME ARMAGNAC	121622	130433
O081	ORME DES FLANDRES	121625	130436
O082	ORME D'AUTREFOIS	121623	130434
O083	ORME LUBERON	121626	130437
O084	ONDE SABLÉE	121946	130599
O110	ORME BRUN	121947	130600
O111	ORGEAT	121948	130601

Bandes de chant mélaminées et CPL



Melamin und CPL Kantenumleimer • Melamine and CPL edgings • Cantos y CPL Melamínicos

Correspondances POLYREY

Panneaux POLYREY		Pré-encollé I, 23mm L 25mL	Non Encollé I, 23mm L 150mL
P001	PIERRE DE LUNE	121287	130124
P039	POIRIER DES FLANDRES	121329	130166
P092	POMME VERTE	121298	130135
P112	PRUNE	121658	130469
P114	POIVRE	121949	130602
P118	PIN ARGENT	121614	130425
P119	PIN MOKA	121627	130438
P120	PIERRE DE LAVE	121636	130447
P133	PIN ICEBERG	121950	130603
P134	PEUPLIER SABLÉ	121951	130604
P135	PIN DE NAGOSHI	121952	130605
P136	PALISSANDRE DE SANTOS	121953	130606
R046	RAPIA	121954	130607
R049	ROUILLE	121637	130448
R060	ROSE VELOURS	121955	130608
R062	ROUGE FATAL	121956	130609
S040	CERUSE CLAIR	121301	130138
S046	SILVERBLACK WOOD	121957	130610
S067	SEIGLE	121958	130611
T006	TECTONICA	121638	130449
T063	TERRE D'OMBRE	121639	130450
T086	TEXTUS GRIS	121639	130450
T087	TEXTUS POIVRE	121640	130451
T105	TECK CARBONE	121959	130612
T106	TANGERINE	121960	130613
T109	TADELAKT AMBRÉ	121961	130614
T110	TADELAKT ROUGE OXYDE	121962	130615
T111	TEXTUS HAVANA	121963	130616
U191	UNDERGROUND CORTEN	121664	130617
U192	UNDERGROUND FONTE	121965	130618
V014	VINYLE	121265	130102
V106	VERT DE GRIS	121966	130619
V108	VERT SARCELLE	121967	130620
V109	VERT BALI	121968	130621
V110	VERT IMPÉRIAL	121969	130622
W009	WENGÉ BLANC CERUSE	121970	130623
W017	WENGÉ POIVRE CERUSE	121971	130624
Z002	ZEBRA MOKA	121304	130141
Z017	ZINGANA	121972	130625





Bandes de chant mélaminées et CPL

Melamin und CPL Kantenumleimer

Melamine and CPL edgings

Cantos y CPL Melamínicos



Guide d'utilisation des tableaux de correspondance

1/ Avec mon code panneau

2/ Je découvre le code décor chant Nordlinger correspondant

3/ Le tableau m'indique où retrouver les formats et encollages disponibles

Correspondances PFLEIDERER

Panneau PFLEIDERER	Décor chant Nordlinger	Page
F70004 (F8582)	ALUMINIUM	I442
R20027 (R4262)	CHÊNE LANCELOT CLAIR	S5124
R24029 (R5829)	HÊTRE FJORD CLAIR	W706
R42012 (F35/049)	MERISIER STYLE MARRON	S5211
R50030 (F21/005)	OLIVIER ESPAGNE CLAIR	S0867
R55001 (R4524)	PIN NAVARRA	S5238
R55028 (R3255)	MÉLÈZE DE SIBIU	S0803
S60012 (F6464/R6604)	BÉTON LISSÉ BRUN	S5237
U11026 (U1026)	BLANC CRISTAL	L001
U11027 (U1027/W1027)	BLANC GLACIER	S0840
U11500 (U1010)	GRIS	S5148
U12007 (U007)	NOIR GRAPHITE	I264 PV
U12007 HG (U007)	NOIR GRAPHITE	S5021
U12168 (U1168)	GRIS CACHEMIRE	S5251
U12290 (U1290)	ANTHRACITE	I296
U16020 (U1313)	CRÈME	S0866
U16130 (U130)	GRIS SABLE	P104 PV
U17019 (U1654)	CRANBERRY	S0812
U18001 (U1715)	BLEU CIEL	S5244
U18074 (U074/U0741)	ATLANTIQUE	S5160
U19005 (U1839)	JADE	S5110
U19008 (U1842)	LABRADOR	S5159
W10003 (W1003)	BLANC OPAL	P121 PV
W10140 (W00140)	BLANC POUR FAÇADE	S0815
W10140 HG (Span 140)	BLANC POUR FAÇADE	S5022

Correspondances SUP BOIS

Panneau SUP BOIS	Décor chant Nordlinger	Page
ACACIA CRÈME MAT	W5012	23
ACACIA TABAC	S0842	19
ALU MAT	I442 PV	19, 28
BÉTON BROSSÉ	S5138	20, 24, 28
BÉTON CLAIR	S5110	20
BÉTON MAT	F5000	19
CHÊNE ANGLAIS	S5119	20
CHÊNE BLANCHI	W1597	23, 24
CHÊNE BRUNI MAT	W1855	23, 24
CHÊNE GRIS	S5120	20, 28
CHÊNE NOUEUX	S5121	20
CHÊNE SONOMA	S5134	20
HÊTRE	S5125	20
PIN LODGE	S5110	20
TECK MAT	W5030	23
LEOPOL	W1856	23
CHAMOIS MAT	S0764	19
CHÊNE BRUN	S5206	21
HÊTRE FUMÉ	S5239	22
PIN VINTAGE	W5020	23



Correspondances EGGER

Panneau EGGER		Décor chant Nordlinger	Page	Panneau EGGER		Décor chant Nordlinger	Page
F105 ST15	Marbre torano	S5226	21	U222 PM/ST2	Blanc ecru	P150	19, 24, 28
F166 ST9	Marbre Pelago blanc	S5191	21	U222 ST9	Blanc Ecru	S5208	21
F186 ST9	Béton Chicago Gris Clair	S5147	21	U321 ST9	Rouge	S5242	22
F222 ST87	Ceramic Tessina lave	S5145	21	U323 ST9	Rouge Cerise	S0875	20
F310 ST87	Ceramic Rouille	S5146	21	U332 ST9	Orange	S0785	19
F365 ST16	Armana Gold	S5137	20	U340 ST9	Orange Sorbet	S5245	22
F501 ST2	Aluminium Brossé	S0895	20	U522 ST9	Bleu Horizon	S0893	20
F509 ST2	Aluminium	I442	19, 28	U630 ST9	Vert Pomme	S5198	21
H1101 ST12	Makassar Café	P119	19	U660 ST9	Vert Amazone	S5252	22
H1133 ST9	Chêne hamilton naturel transversal	S5204	21	U702 PM/ST2	Gris cachemire	S0815	19
H1145 ST10	Chêne Bardolino naturel	S5134	20	U7021 ST9	Gris cachemire intégral	S0815	19
H1180 ST37	Chêne Halifax naturel	S5037	20, 28	U707 ST9	Soie Grise	S0813	19
H1277 ST9	Acacia de Lakeland crème	S5215	21	U708 PM/ST2	Gris clair	S5110	20
H1334 ST9	Chêne Sorano Clair	S5123	20	U708 ST9	Gris Clair	P121 PV	19, 24
H1387 ST10	Chêne Denver Graphite	S5206	21	U7081 ST9	Gris clair intégral	P121 PV	19, 24
H1399 ST10	Chêne Denver chamois	S5132	20	U717 ST9	Gris Mastic	S5244	22
H1424 ST22	Fineline Crème	S5237	22	U727 PM/ST2	Gris argile	S5218	21
H1582 ST15	Hetre de Tyrol	W937	22	U741 ST9	Brun Taupe	S5220	21
H1733 ST9	Bouleau de Mainau	W1421	22, 28	U750 ST9	Gris Souris	S0815	19
H1734 ST9	Noyer intarsio transversal	S5231	22	U788 ST9	Gris Arctique	S5160	21
H3025 HG	Makassar	W1427	22	U7881 ST9	Gris arctique intégral	S5160	21
H3080 ST15	Mahogany	S5112	20	U795 ST9	Brun Glaise	S5182	21
H3081 ST22	Pin Havana Noir	S0761	19	U961 PM/ST2	Gris graphite	S0843	19
H3090 ST22	Shorewood	S5132	20	U961 ST2	Gris Graphite	S5236	22
H3131 ST12	Chêne Davos naturel	S5037	20, 28	U963 ST9	Gris Ombre	S0843	19
H3170 ST12	Chêne Kendal naturel	S5037	20, 28	U9631 ST9	Gris ombre intégral	I296 PV	19
H3303 ST10	Chêne Hamilton naturel	S5204	21	U999 HG	Noir	S5021	20, 24
H3332 ST10	Chêne Nebraska gris	S5107	20, 24, 28	U999 ST12	Noir	S5021	20, 24
H3342 ST28	Chêne Gladstone lave	W1855	23, 24	U999 ST2	Noir	I264 PV	19, 28
H3368 ST9	Chêne de Lancaster naturel	S5117	20	U999 ST38	Noir	S0869	19
H3395 ST12	Chêne Corbridge naturel	W542	22	U9991 ST15	Noir intégral	S0869	19
H3700 ST10	Noyer du Pacifique naturel	S5130	20	W1000 HG	Blanc Premium	P268	19
H3702 ST10	Noyer du Pacific tabac	S0773	19, 24	W1000 ST9	Blanc Premium	P150 PV	19, 24, 28
H3766 ST29	Orme du cap blanc	S5206	21	W1001 HG	Blanc premium intégral	P268	19
H433 ST86	Pin Aland polaire transversal	S5237	22	W1001 ST9	Blanc premium intégral	P150 PV	19, 24, 28
H877 ST86	Acacia de Lakeland crème transversal	S5215	21	W1100 PM/ST2	Blanc alpin	L001	19
U104 ST9	Blanc Albâtre	S5235	22	W1300 ST9	Blanc Polaire	S0840	19, 28
U108 ST9	Jaune Vanille	P119PV	19	W908 SM	Blanc Craie	P099 SL	19, 24, 28
U114 ST9	Jaune Tournesol	S0769	19	W908 ST2	Blanc Craie	P099 PV	19, 24, 28
U156 ST9	Beige Rosé	S5148	21	W980 SM	Blanc Kaolin	P099 SL	19, 24, 28
U200 ST9	Beige	S5162	21	W980 ST2	Blanc Kaolin	P099 PV	19, 24, 28



Bandes de chant mélaminées et CPL

Melamin und CPL Kantenumleimer • Melamine and CPL edgings • Cantos y CPL Melamínicos



Correspondances KRONOSWISS

Panneau KRONOSWISS		Décor chant Nordlinger	Page	Panneau KRONOSWISS		Décor chant Nordlinger	Page
D1308 PE	Mettalic Silver	I442	19, 28	U162 BS	Graphite	I296	19
D1926 SD	Moscow Ash	S5205	21	U164 VL	Anthracite	I296	19
D2240 VL	Niagara Oak	S5135	20	U190 BS	Black	S0869	19
D2293 VL	Newport Oak	S5238	22	U190 HG	Black	S5021	20, 24
D237 OW	Zonza Beech	S5239	22	U190 PE	Black	I264	19, 28
D2414 VL	Budapest Oak	S5204	21	U2509 VL	Limette	W1600	22
D2533 VL	Gotland Maple	S0803	19	U2510 VL	Caribbean	S0893	20
D2541 VL	Swiss Elm Cool	S5113	20	U2511 VL	Bordeau	S5029	20
D2566 PE	Twist	S5108	20, 28	U2645 VL	Jaffa Orange	S0785	19
D2693 OW	Velvet Oak	S0867	19	U2653 VL	Light Grey	S0813	19
D3025 SD	Sonoma Oak	S5121	20	U3188 VL	Toffee	S0845	19
D3191 SW	Cracow Elm	S5113	20	U3189 VL	Truffle	S5182	21
D3192 SW	Berlin Elm	S5037	20, 28	U3261 VL	Vanilla	S5208	21
D3312 SP	Warsaw Oak	S5107	20, 24, 28	U4813 VL	Lavendel	S5241	22
D3313 SP	ST Petersburg Oak	S5037	20, 28	U4827 VL	Jasmund Beech	S5194	21
D3798 CL	London Oak	S5121	20	U515 VL	Sand	P104	19, 28
D3800 CL	Rome Oak	S5237	22	U520 BS	Ice Cream	S5208	21
D3807 OW	Zurich Beech	S5194	21	U566 BS	White	P150	19, 24, 28
D3810 OW	Nice Walnut	S5129	20	U566 HG	White Island	S5022	20
D3811 OW	Venice Walnut	W5005	23	U566 PE	White	P150 PV	19, 24, 28
D3817 OW	Minsk Marron	S0773	19, 24	U566 SE	White	P099	19, 24, 28
D3818 OW	Lviv Marron	S5113	20	U570 VL	White Porcelain	P099	19, 24, 28
D3819 OW	Toulouse Marron	S5231	22	U7110 VL	Coral Red	I267	19
D3820 OW	Bern Marron	S5130	20	U8681 VL	White Alaska	S0840	19, 28
D3823 OW	New York Oak	S5037	20, 28	W1855 VL	Gagliano oak	W1855	23, 24
D391 OW	Light Beech	W937	22				
D3977 VL	Anchorage Poplar	W1421	22, 28				
D3979 VL	Quebec Wild Maple	S5193	21				
D3999 OW	Nairobi Red Etimoa	W1637	23				
D4103 CS	Lucerne Elm	S5243	22				
D4822 OW	Sarlat Walnut	S5202	21				
D4824 SD	White Planks	S5199	21				
K101 PE	Front White	P150	19, 24, 28				
K101 SM	Front White	P150	19, 24, 28				
K110 PE	Interior White	P150 PV	19, 24, 28				
K110 SM	Interior White	P268	19				
U112 BS	Grey	S0813	19				
U112 VL	Grey	S0813	19				
U148 VL	Red	S0875	20				



Bandes de chant mélaminées

Melamin Kantenumleimer • Melamine edgings • Cantos Melamínicos



Ep. ± 0,3 mm	L.	Non Encollé (Mélantor) non pre-glued • ohne Schmelzkleber sin cola				Pré Encollé (Mélafix) pre-glued • mit Schmelzklebe con cola					Auto-Adhésif (Méladhésif) self-adhesive • selbstklebend autoadhesivo			
		23 mm				23 mm		23 mm			16 mm		19 mm	
		5 ml	25 ml	100 ml	150 ml	5 ml	25 ml	25 ml	50 ml	100 ml	5 ml	25 ml	5 ml	25 ml
Décor chant	Surface	Ref Pdt												
F5000		-	-	-	-	070697 7	-	-	-	070743 1	-	-	-	-
F5002	SL	-	-	-	-	070817 9	-	-	-	-	-	-	-	-
F5003	SL	-	-	-	-	070818 6	-	-	-	-	-	-	-	-
F5020		-	-	-	-	-	-	-	-	-	-	-	160181 3	-
I264	L	-	-	061582 8	-	071030 1	074076 6	-	071802 4	075546 3	160008 3	160019 9	160002 1	160016 8
I264	G	-	-	061474 6	-	071220 6	074283 8	-	075690 3	075534 0	-	-	-	-
I267	L	-	-	061651 1	-	071228 2	074338 5	-	075699 6	070366 2	-	-	-	-
I296	G	-	-	060060 2	-	070796 7	074408 5	-	075839 6	070367 9	-	-	160174 5	-
I442		-	-	060131 9	-	070232 0	070451 5	-	070334 1	070375 4	160098 4	-	160113 4	-
I446	G	-	-	-	-	-	-	-	-	-	-	-	160108 0	-
I491	L	-	-	-	-	-	-	-	-	-	-	-	160109 7	-
I1004	SL	-	-	-	-	070857 5	-	-	-	-	-	-	-	-
I1006	SL	-	-	-	-	070856 8	-	-	-	-	-	-	-	-
L001	L	-	-	-	-	071023 3	074061 2	-	-	-	-	-	-	-
P099	L	-	-	061323 7	-	071029 5	074066 7	-	075457 2	075462 6	160007 6	160023 6	160001 4	160013 7
P099	G	-	-	061472 2	-	071257 2	074069 8	-	075493 0	075461 9	160213 1	-	-	-
P104	G	-	-	061598 9	-	071328 9	074224 1	-	075658 3	075744 3	-	-	-	-
P119	G	-	-	060119 7	-	074208 1	074072 8	-	074505 1	070359 4	-	-	-	-
P121	L	-	-	061560 6	-	071027 1	074065 0	-	070301 3	070361 7	-	-	160102 8	160131 8
P121	G	-	-	061584 2	-	074446 7	074347 7	-	075657 6	075781 8	-	-	-	-
P150	L	-	-	061427 2	-	071024 0	074062 9	-	075513 5	075468 8	-	-	-	-
P150	G	-	-	061476 0	-	071306 7	074293 7	-	075590 6	075492 3	-	-	-	-
P268	VB	-	-	060205 7	-	071025 7	074063 6	-	-	-	-	-	-	-
P1001	SL	-	-	-	-	070815 5	-	-	-	-	-	-	-	-
S0755	S1	-	-	-	130626 8	121992 6	122128 8	122287 2	-	-	-	-	-	-
S0756	S1	-	-	-	130627 5	121890 5	122129 5	122288 9	-	-	-	-	-	-
S0757	S1	-	-	-	130628 2	121888 2	122130 1	122289 6	-	-	-	-	-	-
S0761	S1	-	-	-	130629 9	121886 8	122131 8	122290 2	-	-	-	-	-	-
S0763	S1	-	-	-	130630 5	121994 0	122132 5	122291 9	-	-	-	-	-	-
S0764	S1	-	-	-	130631 2	121974 2	122133 2	122292 6	-	-	-	-	-	-
S0765	S1	-	-	-	130632 9	121996 4	122134 9	122293 3	-	-	-	-	-	-
S0769	S1	-	-	-	130633 6	121997 1	122135 6	122294 0	-	-	-	-	-	-
S0773	S1	-	-	-	130634 3	121587 4	122136 3	122295 7	-	-	-	-	-	-
S0775	S1	-	-	-	130635 0	121998 8	122137 0	122296 4	-	-	-	-	-	-
S0785	S1	-	-	-	130636 7	121999 5	122138 7	122297 1	-	-	-	-	-	-
S0803	S1	-	-	-	130637 4	122000 7	122139 4	122298 8	-	-	-	-	-	-
S0804	FM	-	-	-	130638 1	121812 7	122140 0	122299 5	-	-	-	-	-	-
S0812	S1	-	-	-	130639 8	122001 4	122141 7	122300 8	-	-	-	-	-	-
S0813	S1	-	-	-	130640 4	122002 1	122142 4	122301 5	-	-	-	-	-	-
S0815	S1	-	-	-	130641 1	122003 8	122143 1	122302 2	-	-	-	-	-	-
S0840	S1	-	-	-	130642 8	122004 5	122144 8	122303 9	-	-	-	-	-	-
S0841	S1	-	-	-	130643 5	122005 2	122145 5	122304 6	-	-	-	-	-	-
S0842	S1	-	-	-	130644 2	122006 9	122146 2	122305 3	-	-	-	-	-	-
S0843	S1	-	-	-	130645 9	122007 6	122147 9	122306 0	-	-	-	-	-	-
S0845	S1	-	-	-	130646 6	122008 3	122148 6	122307 7	-	-	-	-	-	-
S0866	S1	-	-	-	130647 3	122009 0	122149 3	122308 4	-	-	-	-	-	-
S0867	S1	-	-	-	130648 0	122010 6	122150 9	122309 1	-	-	-	-	-	-
S0868	S1	-	-	-	130649 7	122011 3	122151 6	122310 7	-	-	-	-	-	-
S0869	S1	-	-	-	130650 3	122012 0	122152 3	122311 4	-	-	-	-	-	-
S0874	S1	-	-	-	130651 0	122013 7	122153 0	122312 1	-	-	-	-	-	-

L : Lisse Smooth • Glatte Oberfläche • Superficie lisa / G : Grainé Embossed • Perl Struktur • Poro soft
 PF : Pores frêne Ash embossing • Dekor Esche • Relieve fresno / VB : Verni brillant Glossy varnish • Glanzlack • Barniz brillo
 VTB : Verni très brillant High gloss varnish • Hochglanz-Lack • Barniz con mucho brillo
 ☼ Jusqu'à épuisement du stock

PANNEAU | FORMATS ET ENCOLLAGES NORDLINGER PRO DISPONIBLES

Bandes de chant mélaminées

Melamin Kantenumleimer • Melamine edgings • Cantos Melamínicos



Ep. ± 0,3 mm	L.	Non Encollé (Mélanor) non pre-glued • ohne Schmelzkleber sin cola				Pré Encollé (Mélafix) pre-glued • mit Schmelzklebe con cola				Auto-Adhésif (Méladhésif) self-adhesive • selbstklebend autoadhesivo					
		23 mm				23 mm				23 mm				16 mm	
Décor chant	Surface	5 ml	25 ml	100 ml	150 ml	5 ml	25 ml	25 ml	50 ml	100 ml	5 ml	25 ml	5 ml	25 ml	
		Ref Pdt													
S0875	S1	-	-	-	130652 7	122014 4	122154 7	122313 8	-	-	-	-	-	-	
S0877	S1	-	-	-	130653 4	122015 1	122155 4	122314 5	-	-	-	-	-	-	
S0880	S1	-	-	-	130654 1	122016 8	122156 1	122315 2	-	-	-	-	-	-	
S0884	S1	-	-	-	130655 8	122017 5	122157 8	122316 9	-	-	-	-	-	-	
S0886	S1	-	-	-	130656 5	122018 2	122158 5	122317 6	-	-	-	-	-	-	
S0893	S1	-	-	-	130657 2	122019 9	122159 2	122318 3	-	-	-	-	-	-	
S0895	S1	-	-	-	130658 9	122020 5	122160 8	122319 0	-	-	-	-	-	-	
S0898	S1	-	-	-	130659 6	122021 2	122161 5	122320 6	-	-	-	-	-	-	
S0914	S1	-	-	-	130663 3	122023 6	122165 3	122323 7	-	-	-	-	-	-	
S0935	S1	-	-	-	130664 0	122024 3	122166 0	122324 4	-	-	-	-	-	-	
S0941	S1	-	-	-	130665 7	122025 0	122167 7	122325 1	-	-	-	-	-	-	
S0946	S1	-	-	-	130666 4	122026 7	122168 4	122326 8	-	-	-	-	-	-	
S0947	S1	-	-	-	130667 1	122027 4	122169 1	122327 5	-	-	-	-	-	-	
S0954	S1	-	-	-	130668 8	122028 1	122170 7	122328 2	-	-	-	-	-	-	
S0960	S1	-	-	-	130669 5	122029 8	122171 4	122329 9	-	-	-	-	-	-	
S0961	S1	-	-	-	130670 1	122030 4	122172 1	122330 5	-	-	-	-	-	-	
S5021	VTB	-	-	060216 3	-	070693 9	070695 3	-	-	070698 4	-	-	-	-	
S5022	VTB	-	-	060218 7	-	070692 2	070694 6	-	-	070700 4	-	-	-	-	
S5029	S1	-	-	-	130673 2	122032 8	122175 2	122333 6	-	-	-	-	-	-	
S5034	FM	-	-	-	130671 8	122031 1	122173 8	122331 2	-	-	-	-	-	-	
S5037	FM	-	-	-	130672 5	121588 1	122174 5	122332 9	-	-	-	-	-	-	
S5107	S1	-	-	-	130680 0	121701 4	122182	122340 4	-	-	-	-	-	-	
S5108	FM	-	-	-	130708 1	122057 1	122210 0	122368 8	-	-	-	-	-	-	
S5109	FM	-	-	-	130707 4	122056 4	122209 4	122367 1	-	-	-	-	-	-	
S5110	S1	-	-	-	130674 9	122032 8	122176 9	122334 3	-	-	-	-	-	-	
S5111	S1	-	-	-	130675 6	122033 5	122177 6	122335 0	-	-	-	-	-	-	
S5112	S1	-	-	-	130676 3	122034 2	122178 3	122336 7	-	-	-	-	-	-	
S5113	FM	-	-	-	130677 0	122035 9	122179 0	122337 4	-	-	-	-	-	-	
S5115	S1	-	-	-	130678 7	122036 6	122180 6	122338 1	-	-	-	-	-	-	
S5117	S1	-	-	-	130679 4	122037 3	122181 3	122339 8	-	-	-	-	-	-	
S5118	S1	-	-	-	130681 7	121883 7	122183 7	122341 1	-	-	-	-	-	-	
S5119	S1	-	-	-	130682 4	121843 1	122184 4	122342 8	-	-	-	-	-	-	
S5120	FM	-	-	-	130683 1	121845 5	122185 1	122343 5	-	-	-	-	-	-	
S5121	S1	-	-	-	130684 8	121887 5	122186 8	122344 2	-	-	-	-	-	-	
S5122	S1	-	-	-	130661 9	122022 0	122163 9	122322 0	-	-	-	-	-	-	
S5123	S1	-	-	-	130685 5	122039 7	122187 5	122345 9	-	-	-	-	-	-	
S5124	S1	-	-	-	130686 2	122040 3	122188 2	122346 6	-	-	-	-	-	-	
S5125	S1	-	-	-	130687 9	121848 6	122189 9	122347 3	-	-	-	-	-	-	
S5127	S1	-	-	-	130688 6	122041 0	122190 5	122348 0	-	-	-	-	-	-	
S5128	S1	-	-	-	130689 3	122042 7	122191 2	122349 7	-	-	-	-	-	-	
S5129	FM	-	-	-	130690 9	122043 4	122192 9	122350 3	-	-	-	-	-	-	
S5130	FM	-	-	-	130691 6	122044 1	122193 6	122351 0	-	-	-	-	-	-	
S5131	FM	-	-	-	130692 3	122045 8	122194 3	122352 7	-	-	-	-	-	-	
S5132	S1	-	-	-	130693 0	122046 5	122195 0	122353 4	-	-	-	-	-	-	
S5133	S1	-	-	-	130694 7	121748 9	122196 7	122354 1	-	-	-	-	-	-	
S5134	FM	-	-	-	130695 4	121844 8	122197 4	122355 8	-	-	-	-	-	-	
S5135	S1	-	-	-	130696 1	122047 2	122198 1	122356 5	-	-	-	-	-	-	
S5136	S1	-	-	-	130697 8	122048 9	122199 8	122357 2	-	-	-	-	-	-	
S5137	FM	-	-	-	130698 5	122049 6	122200 1	122358 9	-	-	-	-	-	-	
S5138	FM	-	-	-	130699 2	121814 1	122201 8	122359 6	-	-	-	-	-	-	
S5140	S1	-	-	-	130700 5	121749 6	122202 5	122360 2	-	-	-	-	-	-	
S5141	S1	-	-	-	130701 2	122050 2	122203 2	122361 9	-	-	-	-	-	-	
S5142	S1	-	-	-	130702 9	122051 9	122204 9	122362 6	-	-	-	-	-	-	
S5143	S1	-	-	-	130703 6	122052 6	122205 6	122363 3	-	-	-	-	-	-	

Bandes de chant mélaminées

Melamin Kantenumleimer • Melamine edgings • Cantos Melamínicos



Ep. ± 0,3 mm	l.	Non Encollé (Mélanor) non pre-glued • ohne Schmelzkleber sin cola				Pré Encollé (Mélafix) pre-glued • mit Schmelzklebe con cola				Auto-Adhésif (Méladhésif) self-adhesive • selbstklebend autoadhesivo					
		23 mm				23 mm				23 mm				16 mm	
Décor chant	Surface	5 ml	25 ml	100 ml	150 ml	5 ml	25 ml	25 ml	50 ml	100 ml	5 ml	25 ml	5 ml	25 ml	
		Ref Pdt													
S5145	FM	-	-	-	130704 3	122053 3	122206 3	122364 0	-	-	-	-	-	-	
S5146	FM	-	-	-	130705 0	122054 0	122207 0	122365 7	-	-	-	-	-	-	
S5147	FM	-	-	-	130706 7	122055 7	122208 7	122366 4	-	-	-	-	-	-	
S5148	S1	-	-	-	130709 8	122058 8	122211 7	122369 5	-	-	-	-	-	-	
S5154	S1	-	-	-	130710 4	122059 5	122212 4	122370 1	-	-	-	-	-	-	
S5155	S1	-	-	-	130711 1	122060 1	122213 1	122371 8	-	-	-	-	-	-	
S5159	S1	-	-	-	130712 8	122061 8	122214 8	122372 5	-	-	-	-	-	-	
S5160	S1	-	-	-	130713 5	122062 5	122215 5	122373 2	-	-	-	-	-	-	
S5162	S1	-	-	-	130714 2	122063 2	122216 2	122374 9	-	-	-	-	-	-	
S5163	S1	-	-	-	130715 9	122064 9	122217 9	122375 6	-	-	-	-	-	-	
S5165	S1	-	-	-	130716 6	122065 6	122218 6	122376 3	-	-	-	-	-	-	
S5171	S1	-	-	-	130717 3	121880 6	122219 3	122377 0	-	121884 4	-	-	-	-	
S5172 *		-	-	-	-	121798 4	121858 5	-	-	-	-	-	-	-	
S5181 *		-	-	-	-	121827 1	-	-	-	-	-	-	-	-	
S5182 *	L	-	-	-	-	121829 5	-	-	-	-	-	-	-	-	
S5183		-	-	-	-	121828 8	-	-	-	-	-	-	-	-	
S5184 *		-	-	-	-	121830 1	-	-	-	-	-	-	-	-	
S5191	FM	-	-	-	130718 0	122066 3	122220 9	122378 7	-	-	-	-	-	-	
S5192	S1	-	-	-	130719 7	122067 0	122221 6	122379 4	-	-	-	-	-	-	
S5193	FM	-	-	-	130720 3	122068 7	122222 3	122380 0	-	-	-	-	-	-	
S5194	FM	-	-	-	130721 0	122069 4	122223 0	122381 7	-	-	-	-	-	-	
S5195	S1	-	-	-	130722 7	122070 0	122224 7	122382 4	-	-	-	-	-	-	
S5196	S1	-	-	-	130723 4	122071 7	122225 5	122383 1	-	-	-	-	-	-	
S5197	FM	-	-	-	130724 1	122072 4	122226 1	122384 8	-	-	-	-	-	-	
S5198	S1	-	-	-	130725 8	122073 1	122227 8	122385 5	-	-	-	-	-	-	
S5199	FM	-	-	-	130726 5	122038 0	122229 2	122386 2	-	-	-	-	-	-	
S5200	FM	-	-	-	130727 2	122074 8	122230 8	122387 9	-	-	-	-	-	-	
S5201	FM	-	-	-	130728 9	122075 5	122231 5	122388 6	-	-	-	-	-	-	
S5202	FM	-	-	-	130729 6	122076 2	122228 5	122389 3	-	-	-	-	-	-	
S5203	FM	-	-	-	130730 2	122077 9	122232 2	122390 9	-	-	-	-	-	-	
S5204	FM	-	-	-	130731 9	122078 6	122233 9	122391 6	-	-	-	-	-	-	
S5205	FM	-	-	-	130732 6	122079 3	122234 6	122392 3	-	-	-	-	-	-	
S5206	FM	-	-	-	130733 3	121976 6	122235 3	122393 0	-	-	-	-	-	-	
S5207	FM	-	-	-	130734 0	122080 9	122236 0	122394 7	-	-	-	-	-	-	
S5208	S1	-	-	-	130735 7	122081 6	122237 7	122395 4	-	-	-	-	-	-	
S5209	S1	-	-	-	130736 4	122082 3	122238 4	122396 1	-	-	-	-	-	-	
S5210	S1	-	-	-	130737 1	122083 0	122239 1	122397 8	-	-	-	-	-	-	
S5211	S1	-	-	-	130738 8	122084 7	122240 7	122398 5	-	-	-	-	-	-	
S5212	FM	-	-	-	130739 5	122085 4	122241 4	122399 2	-	-	-	-	-	-	
S5213	FM	-	-	-	130740 1	122086 1	122242 1	122400 5	-	-	-	-	-	-	
S5214	FM	-	-	-	130741 8	122087 8	122243 8	122401 2	-	-	-	-	-	-	
S5215	S1	-	-	-	130742 5	122088 5	122244 5	122402 9	-	-	-	-	-	-	
S5216	S1	-	-	-	130743 2	122089 2	122245 2	122403 6	-	-	-	-	-	-	
S5217	S1	-	-	-	130744 9	122090 8	122246 9	122404 3	-	-	-	-	-	-	
S5218	S1	-	-	-	130745 6	122091 5	122247 6	122405 0	-	-	-	-	-	-	
S5219	S1	-	-	-	130746 3	122092 2	122248 3	122406 7	-	-	-	-	-	-	
S5220	S1	-	-	-	130747 0	122093 9	122249 0	122407 4	-	-	-	-	-	-	
S5221	S1	-	-	-	130748 7	122094 6	122250 6	122408 1	-	-	-	-	-	-	
S5222	S1	-	-	-	130749 4	122095 3	122251 3	122409 8	-	-	-	-	-	-	
S5224	FM	-	-	-	130750 0	122096 0	122252 0	122410 4	-	-	-	-	-	-	
S5225	FM	-	-	-	130751 7	122097 7	122253 7	122411 1	-	-	-	-	-	-	
S5226	FM	-	-	-	130752 4	122098 4	122254 4	122412 8	-	-	-	-	-	-	
S5227	FM	-	-	-	130753 1	122099 1	122255 1	122413 5	-	-	-	-	-	-	
S5228	FM	-	-	-	130754 8	122100 4	122256 8	122414 2	-	-	-	-	-	-	

* Jusqu'à épuisement du stock

PANNEAU | FORMATS ET ENCOLLAGES NORDLINGER PRO DISPONIBLES

Bandes de chant mélaminées

Melamin Kantenumleimer • Melamine edgings • Cantos Melamínicos



Ep. ± 0,3 mm	L.	Non Encollé (Mélanor) non pre-glued • ohne Schmelzkleber sin cola				Pré Encollé (Mélafix) pre-glued • mit Schmelzklebe con cola					Auto-Adhésif (Méladhésif) self-adhesive • selbstklebend autoadhesivo			
		23 mm				23 mm					16 mm		19 mm	
		5 ml	25 ml	100 ml	150 ml	5 ml	25 ml	25 ml	50 ml	100 ml	5 ml	25 ml	5 ml	25 ml
Décor chant	Surface	Ref Pdt												
S5229	FM	-	-	-	130755 5	122101 1	122257 5	122415 9	-	-	-	-	-	
S5230	FM	-	-	-	130756 2	122102 8	122258 2	122416 6	-	-	-	-	-	
S5231	FM	-	-	-	130757 9	122103 5	122259 9	122417 3	-	-	-	-	-	
S5232	FM	-	-	-	130758 6	122104 2	122260 5	122418 0	-	-	-	-	-	
S5233	S1	-	-	-	130759 3	122105 9	122261 2	122419 7	-	-	-	-	-	
S5234	FM	-	-	-	130760 9	122106 6	122262 9	122420 3	-	-	-	-	-	
S5235	S1	-	-	-	130761 6	122107 3	122263 6	122421 0	-	-	-	-	-	
S5236	S1	-	-	-	130762 3	122108 0	122264 3	122422 7	-	-	-	-	-	
S5237	FM	-	-	-	130763 0	122109 7	122265 0	122423 4	-	-	-	-	-	
S5238	FM	-	-	-	130764 7	122110 3	122266 7	122424 1	-	-	-	-	-	
S5239	S1	-	-	-	130765 4	121977 3	122267 4	122425 8	-	-	-	-	-	
S5240	S1	-	-	-	130766 1	122111 0	122268 8	122426 5	-	-	-	-	-	
S5241	S1	-	-	-	130767 8	122112 7	122268 1	122427 2	-	-	-	-	-	
S5242	S1	-	-	-	130768 5	122113 4	122270 4	122428 9	-	-	-	-	-	
S5243	FM	-	-	-	130769 2	122114 1	122271 1	122429 6	-	-	-	-	-	
S5244	S1	-	-	-	130770 8	122115 8	122272 8	122430 2	-	-	-	-	-	
S5245	S1	-	-	-	130771 5	122116 5	122273 5	122431 9	-	-	-	-	-	
S5246	FM	-	-	-	130772 2	122117 2	122274 2	122432 6	-	-	-	-	-	
S5247	FM	-	-	-	130773 9	122118 9	122275 9	122433 3	-	-	-	-	-	
S5248	FM	-	-	-	130774 6	122119 6	122276 6	122434 0	-	-	-	-	-	
S5250	FM	-	-	-	130775 3	122120 2	122277 3	122435 7	-	-	-	-	-	
S5251	S1	-	-	-	130776 0	122121 9	122278 0	122436 4	-	-	-	-	-	
S5252	S1	-	-	-	130777 7	122122 6	122279 7	122437 1	-	-	-	-	-	
S5253	S1	-	-	-	130778 4	122123 3	122280 3	122438 8	-	-	-	-	-	
S5254	S1	-	-	-	130779 1	122124 0	122281 0	122439 5	-	-	-	-	-	
S5255	FM	-	-	-	130780 7	122125 7	122282 7	122440 1	-	-	-	-	-	
S5256	FM	-	-	-	130781 4	122126 4	122283 4	122441 8	-	-	-	-	-	
S5257	FM	-	-	-	130782 1	122127 1	122284 1	122442 5	-	-	-	-	-	
SB3		-	-	-	-	151001 6	151003 0	-	-	-	-	-	-	
W013		-	-	060069 5	-	071874 1	071723 2	-	071744 7	070338 9	160048 9	-	160044 1	160126 4
W014		-	-	-	-	070801 8 *	-	-	-	-	-	-	160103 5	-
W020		070057 9	071867 3	060072 5	070089 0	070057 9	071867 3	070060 9	070099 9	070349 5	160012 0	-	160006 9	160021 2
W080		-	-	060115 9	-	070033 3	071868 0	-	070100 2	070350 1	-	-	-	-
W108		-	-	060108 1	-	070403 4	074688 1	-	071842 0	071687 7	-	-	-	-
W211 *		-	-	060055 8	-	070197 2	070193 4	-	070170 5	070175 0	-	-	-	-
W316		-	-	060130 2	-	070234 4	070419 5	-	070321 1	070374 7	160009 0	-	160003 8	160031 1
W495		-	-	060066 4 *	-	070186 6 *	070185 9 *	-	070148 4 *	070372 3 *	-	-	160068 7	160088 5
W522		-	-	061603 0	-	071278 7	074292 0	-	075672 9	075785 6	160101 1	-	160100 4	-
W542		-	-	061663 4	-	071044 8	074094 0	-	071812 3	075685 9	-	-	160176 9	-
W561 *		-	-	061605 4	-	071226 8	074104 6	-	074508 2	075463 3	-	-	-	-
W593		-	-	060068 8	-	071054 7	074170 1	-	070084 5	070342 6	-	-	-	-
W602 *		-	-	061606 1 *	-	071049 3 *	074098 8 *	-	075659 0 *	075740 5 *	160011 3	160130 1	160005 2	160033 5
W611		-	-	-	-	-	-	-	-	-	160010 6	-	160004 5	160032 8
W706		-	-	060129 6	-	070417 1	070420 1	-	070322 8	070373 0	-	-	-	-
W897		-	-	061612 2	-	071343 2	074552 5	-	071813 0	070346 4	-	-	160144 8	-
W933 *		-	-	061788 4	-	071801 7	071717 1	-	071741 6	071803 1	-	-	-	-
W937		-	-	061676 4	-	071397 5	074694 2	-	071815 4	071492 7	160015 1	-	160014 4	160022 9
W992		-	-	060054 1	-	070189 7	070267 2	-	070169 9	070174 3	-	-	-	-
W1421		-	-	061770 9	-	071400 2	074708 6	-	071816 1	070347 1	160020 5	-	160046 5	-
W1427 *		-	-	-	-	070535 2	070685 4	-	-	-	-	-	-	-
W1572		-	-	060132 6	-	070233 7	070270 2	-	070263 4	070376 1	160086 1	160104 2	160087 8	160127 1
W1597		-	-	-	-	070802 5	070681 6	-	-	-	-	-	-	-
W1600 *	L	-	-	-	-	070514 7	-	-	-	-	-	-	-	-
W1634		-	-	-	-	070539 0	070678 6	-	-	070745 5	160175 2	-	160140 0	-

Bandes de chant mélaminées

Melamin Kantenumleimer • Melamine edgings • Cantos Melamínicos



Ep. ± 0,3 mm	Non Encollé (Mélanor) non pre-glued • ohne Schmelzkleber sin cola					Pré Encollé (Mélafix) pre-glued • mit Schmelzklebe con cola					Auto-Adhésif (Méladhésif) self-adhesive • selbstklebend autoadhesivo			
	L.	23 mm				23 mm		23 mm			16 mm		19 mm	
		L.	5 ml	25 ml	100 ml	150 ml	5 ml	25 ml	25 ml	50 ml	100 ml	5 ml	25 ml	5 ml
Décor chant	Surface	Ref Pdt												
W1635		-	-	-	-	070540 6	070684 7	-	-	-	-	-	-	-
W1637 *		-	-	-	-	070536 9	070688 5	-	-	070736 3	-	-	-	-
W1638 *		-	-	-	-	070537 6	070687 8	-	-	-	-	-	-	-
W1855 *		-	-	-	-	070668 7	070683 0	-	-	-	-	-	160137 0	-
W1856		-	-	-	-	070670 0	070677 9	-	071446 0	070734 9	-	-	-	-
W1857		-	-	-	-	070669 4	070679 3	-	-	070578 9	-	-	160138 7	-
W5000 *		-	-	-	-	070671 7	070686 1	-	-	-	-	-	-	-
W5005 *		-	-	-	-	070708 0	070733 2	-	-	-	-	-	-	-
W5010		-	-	-	-	070752 3	-	-	-	-	-	-	-	-
W5011 *		-	-	-	-	070753 0	070823 0	-	-	-	-	-	-	-
W5012		-	-	-	-	070758 5	-	-	-	-	-	-	-	-
W5013 *		-	-	-	-	070794 3	-	-	-	-	-	-	-	-
W5018 *		-	-	-	-	-	-	-	-	-	160143 1	-	-	-
W5019		-	-	-	-	070579 6	-	-	-	-	-	-	-	-
W5020		-	-	-	-	070853 7	-	-	-	-	-	-	160221 6	-
W5021		-	-	-	-	-	-	-	-	-	-	-	160225 7	-
W5022		-	-	-	-	-	-	-	-	-	-	-	160224 7	-
W5023		-	-	-	-	-	-	-	-	-	-	-	160223 0	-
W5026		-	-	-	-	-	-	-	-	-	-	-	160226 1	-
W5027		-	-	-	-	-	-	-	-	-	-	-	160222 3	-
W5028		-	-	-	-	070822 3	-	-	-	-	-	-	-	-
W5029		-	-	-	-	070819 3	-	-	-	-	-	-	160227 8	-
W5030		-	-	-	-	070820 9	-	-	-	-	-	-	-	-
W5034		-	-	-	-	070854 4	-	-	-	-	-	-	-	-
W5036		-	-	-	-	070855 1	-	-	-	-	-	-	-	-



L : Lisse Smooth • Glatte Oberfläche • Superficie lisa / G : Grainé Embossed • Perl Struktur • Poro soft
 PF : Pores frêne Ash embossing • Dekor Esche • Relieve fresno / VB : Verni brillant Glossy varnish • Glanzlack • Barniz brillo
 VTB : Verni très brillant High gloss varnish • Hochglanz-Lack • Barniz con mucho brillo
 * Jusqu'à épuisement du stock

PANNEAU | CHANT

Bandes de chant mélaminées > largeurs spéciales

Melamine edgings >
Special widths
Melamin Kantenumleimer >
Spezielle Breiten
Cantos Melamínicos >
Anchos especiales



Ep. ± 0,3 mm

Non Encollé (Mélanor)	Pré Encollé (Mélafix)	
non pre-glued ohne Schmelzkleber sin cola	pre-glued • mit Schmelzklebe • con cola	



L.	100 ml	5 ml	25 ml	100 ml
----	--------	------	-------	--------

	Code	Décor	Surface	Ref Pdt					
20 mm	P099	Blanc White • weiss • blanco	L	061594 1	061003 8	071190 2	074193 0	075664 4	075012 3
	P099		G	-	060105 0	070041 8	074287 6	-	075234 9
	P150		L	-	061002 1	071004 2	074008 7	-	075013 0
	P150		G	-	060136 4	-	070027 2	-	-
26 mm	P099	Blanc White • weiss • blanco	G	060093 0	061190 5	-	-	-	071547 4
	P099		L	060076 3	061167 7	-	070423 2	070303 7	070035 7
	P150		G	061785 3	060010 7	-	-	-	070217 7
	P150		L	061564 4	061672 6	-	-	-	070238 2
34 mm	P099	Blanc / Super White • weiss • blanco	L	-	-	070797 4	-	-	-
	W1601	Brun taupe Moka Moka	G	-	-	070750 9	-	-	-
	S5107	Chêne authentique / Gris / H443 Colorado Oak • Eiche • Roble		-	-	121811 0	-	-	-
	S0773	Noyer Walnut • Nussbaum • Nogal		-	-	121975 9	-	-	-
	P121	Gris clair / Béton clair SB Grey • Grau • Gris	L	-	-	070749 3	-	-	-
	F5003	Béton loft Concrete • Beton • Hormigon		-	-	070818 6	-	-	-
	S5138	Béton minéral / Griffé / Oxid 37 Concrete • Beton • Hormigon		-	-	121815 8	-	-	-
	S0804	Pin nouveaux grisé Pine grey • Grün • Pino gris		-	-	121813 4	-	-	-
	W5011	Chêne scié 868 Oak • Eiche • Roble		-	-	070754 7	-	-	-
	W1597	Planche blanc usé / Ch blanchi / Antique Oak • Eiche • Roble		-	-	070798 1	-	-	-
	W1634	Chêne nat clair 387 Oak • Eiche • Roble		-	-	070748 6	-	-	-
	W5029	Bois blanchi		-	-	070826 1	-	-	-
	W1855	Planche noir usé / Chêne anthracite / Foncé Oak • Eiche • Roble		-	-	070800 1	-	-	-
38 mm	S5021	Noir très brillant		-	-	070709 7	-	-	-

* Jusqu'à épuisement du stock

Bandes de chant CPL (stratifiées)

CPL Edgings
CPL Kantenumleimer
Cantos CPL

Non Encollé (Mélanor)	Pré Encollé (Mélafix)	
non pre-glued ohne Schmelzkleber sin cola	pre-glued mit Schmelzklebe con cola	
ℓ. 23 mm		
	100 ml	25 ml
		25 ml

Type	Code	Décor	Surface	Ref Pdt		
Blanc	P099	Blanc White • weiss • blanco	L	120036 8	120055 9	120049 8
	P099		G	120025 2	120056 6	121398 8



Bandes de chant bois véritable

Natural wood veneer edgings • Echtholz Furnier Kanten • Cantos de chapa de madera

	Non Encollé (Rolchant) non pre-glued ohne Schmelzkleber • sin cola	Pré Encollé (Rolfix) pre-glued • mit Schmelzklebe • con cola			Non Encollé Épais (Alèse Bois) non pre-glued • ohne Schmelzkleber sin cola		
	Ep.	+/- 0,6 mm	+/- 0,6 mm			+/- 2 mm	+/- 3 mm
	ℓ	23 mm	23 mm	40 mm	23 mm	24 mm	
L.	100 ml	100 ml	20 ml	5 ml	50 ml		
Essence	Ref Pdt						
Chêne Oak • Eiche • Roble	290502 6	260103 4	260503 2	260517 9	220702 1	250412 0	250142 6
Acajou Mahogany • Mahagoni • Caoba	290505 7	260100 3	260500 1	260507 0	220700 7	250000 9	-
Aniégré Aniegre • Anegre • Mukaly	290506 4	260101 0	260541 4	-	220701 4	-	-
Châtaignier Chestnut-tree • Kastagne • Castaño	290518 7	260102 7	260601 5	-	220029 9	-	-
Érable Maple • Ahorn • Arce	290314 5	260697 8	260708 1	-	220030 5	250039 9	-
Frêne Ash • Esche • Fresno	290500 2	260105 8	260504 9	260538 4	220703 8	250413 7	-
Hêtre Beech • Buche • Haya	290507 1	260106 5	260506 3	260539 1	220704 5	250298 0	-
Hêtre étuvé Beech • Buche • Haya	290000 7	260009 9	260013 6	-	220037 4	250327 7	-
Koto	290514 9	260107 2	260518 6	-	220705 2	-	-
Merisier Cherry • Kirsche • Cerezo	290504 0	260110 2	260523 0	260024 2	220707 6	250465 6	-
Noyer Walnut • Nussbaum • Nogal	290508 8	260111 9	260524 7	-	220708 3	250041 2	-
Okoumé Okoume • Okume	290510 1	260112 6	260519 3	260021 1	220710 6	-	-
Orme Elm • Ulme • Olmo	-	260113 3	260520 9	-	220709 0	-	-
Pin Pine • Kiefer • Pino	290503 3	260114 0	260505 6	260569 8	220711 3	250466 3	-
Sapin Fir-tree • Tanne • Pino	290554 5	260143 0	260537 7	-	220815 8	-	-
Teck Teak • Teca	290517 0	260116 4	260521 6	260030 3	220714 4	250040 5	-
Wengé Wenge	290057 1	290073 1	290043 3	260059 4	-	-	-



Chant bois sur support non tissé



L : Lisse Smooth • Glatte Oberfläche • Superficie lisa / G : Grainé Embossed • Perl Struktur • Poro soft

VB : Verni brillant Glossy varnish • Glanzlack • Barniz brillo / VTB : Verni très brillant High gloss varnish • Hochglanz-Lack • Barniz con mucho brillo

⊛ Jusqu'à épuisement du stock

✔ Disponible en 40 mm Available in 40 mm • Auch in 40 mm •

PANNEAU | PLACAGE BOIS



Placage bois

Wood veneer • Echtholz Furniere
Chapa madera

L. 2,50 ml | Ep. 0,6 mm | u.c. x1



Illustrations d'utilisation

Illustrations of use • Anwendungsbeispiele • Ilustraciones de uso



Non Encollé (Plac-nor)

non pre-glued
ohne Schmelzkleber
sin cola

Pré Encollé (Plac-fix)

pre-glued
mit Schmelzklebe
con cola

Décor	Ref Pdt			
	25 cm	50 cm	25 cm	50 cm
Acajou Mahogany • Mahogoni • Caoba	500100 8	500300 2	510000 8	510200 2
Chêne Oak • Eiche • Roble	500101 5	500301 9	510001 5	510201 9
Hêtre Beech • Buche • Haya	500111 4	500210 4	510018 3	510017 6
Koto	500103 9	500303 3	510003 9	510203 3
Merisier Cherry • Kirsche • Cerezo	500104 6	500304 0	510004 6	510204 0
Noyer Walnut • Nußbaum • Nogal	500105 3	500305 7	510005 3	510205 7
Pin Pine • Kiefer • Pino	500107 7	500307 1	510007 7	510207 1
Teck Teak • Teakholz • Teca	500109 1	500309 5	510009 1	510209 5

BIEN
VU

Capacité :
25 rouleaux



Ref Pdt 940121 7

Revêtement adhésif

Self-adhesive foil • Selbstklebefolie • Pelcula autoadesiva



AVANT

Before • Vorher • Antes



APRÈS

After • Nachher • Después

Auto Adhésif (Placflex)

Self-adhesive •
Selbstklebend • Autoadhesivo



l. 0,90 ml
L. 2,15 ml
u.c. x1

Décor	Ref Pdt
Aluminium brossé Alu	600013 0
Blanc White • weiss • blanco	600001 7
Hêtre Beech • Buche • Haya *	600011 6
Inox	600015 4
Relief damier alu *	600014 7

* Jusqu'à épuisement du stock

Profilés plastiques

Plastic Profile • Plástica Profile • Perfiles plásticos

Angle

Désignation	Couleur	ℓ.	L.	Ref Pdt	u.c.	x 25
Profilé de renvoi d'angle (YR) Reversing angle profile Doppel-Eck-Profil Perfil doble ángulo	Blanc White Weiss Blanco	16 mm	2,75 ml	670051 1		
		19 mm		670050 4		
Profilé de construction d'angle (PCA) Profile for angle construction Bauprofil für Winkel Perfil construcción de ángulo	Blanc White Weiss Blanco	18-19 mm	2,50 ml	670236 0		
			2,75 ml	670184 6		
Profilé Quart de rond (PQR) Quarter round profile Viertel kreis profil Perfil cuarto de luna	Blanc White Weiss Blanco	15 x 15 mm	3 ml	670075 7		
Cornière de finition (LR) Finishing profile Fertigstellung Eck-profil Perfil de terminación	Blanc White Weiss Blanco	20 mm	2,75 ml	670235 5		
		15 mm		670084 9		
		20 mm		670052 8		
		25 mm		670091 7		
		30 mm		670085 6		
		35 mm		670086 3		
		40 mm		670087 0		
50 mm	670088 7					

Jonction de panneaux

Désignation	Couleur	ℓ.	L.	Ref Pdt	u.c.	x 25
Profilé en H de raccord (HR) H profile H Profil Perfil plástico en H	Blanc White Weiss Blanco	19 mm	2,50 ml	670237 9		
		3-4 mm		670096 2		
		10 mm		670115 0		
		16 mm		670049 8		
Profilé en T de raccord (TR) T Profile T Profile Perfil en T	Blanc White Weiss Blanco	25-18 mm	2,50 ml	670238 6		
			2,75 ml	670169 3		



Chant du Panneau

Chant rigide type U (UR) U Type rigid edgings
 U Förmige Hart Kanten • Perfiles U rigido

u.c. x 25



Décor	Ref Pdt						
	ℓ.	8 mm	10 mm	12 mm	16 mm	19 mm	22 mm
	L.	2,75 ml					
Blanc White • Weiss • Blanco		670093 1	670037 5	670038 2	670039 9	670036 8	670040 5
Noir Black • Schwarz • Negro		-	-	-	-	670064 1	-
Gris Grey • Grau • Grisalla		-	-	-	-	670065 8	-
Chêne clair Oak • Eiche • Roble		-	-	-	-	670062 7	-
Hêtre Beech • Buche • Haya		-	-	-	-	670070 2	-

Profilé «Queue de sapein» Thermo-plastic edge
 "T" profile • Thermo-plastisches "T" profil • Perfiles termo-plásticos tipo "Espina de pescado"



u.c. x 1

Arasable (GSA) Anchnittsfähig • Refilable

Décor	Ref Pdt		
	ℓ.	15-21 mm	21-26 mm
	L.	25 ml	
Blanc White • Weiss • Blanco		720019 5	-
Noir Black • Schwarz • Negro		720020 1	019017 2
Gris/Noir Grey/Black • Grau/Schwarz • Grisalla/Negro		720022 5	019011 0

Couvre chant souple (CCS) Soft plastic covering edgings
 Umschließende Weichkunststoff-kanten • Cubrecantos flexible

u.c. x 1



Décor	Ref Pdt				
	ℓ.	16 mm	18 mm	16 mm	18 mm
	L.	2 ml		25 ml	
Blanc White • Weiss • Blanco		670000 9	670009 2	670054 2	670041 2
Noir Black • Schwarz • Negro		670001 6	670010 8	670053 5	670118 1
Aluminium Alu		670128 0	670129 7	670147 1	670146 4
Chêne clair Oak • Eiche • Roble		670006 1	670015 3	670061 0	670148 8
Hêtre clair Beech • Buche • Haya		670007 8 *	-	670059 7 *	-

Demi-rond creux (QSDC) Empty half round • Halbrund hohl
 Media luna hueco

u.c. x 1

Décor	Ref Pdt			
	ℓ.	20 mm	25 mm	30 mm
	L.	25 ml		20 ml
Blanc White • Weiss • Blanco		019004 2	-	-
Gris Grey • Grau • Grisalla		-	019007 3	-
Noir Black • Schwarz • Negro		-	019008 0	019009 7
Rouge Red • Rot • Rojo		019005 9 *	-	-

Demi-rond plein (QSP) Full half round • Halbrund flach, massiv
 Media luna macizo

u.c. x 1

Décor	Ref Pdt			
	L.	100 ml	ℓ.	19 mm
Blanc White • Weiss • Blanco				019013 4

* Jusqu'à épuisement du stock

Araseurs de chant

Pour une meilleure finition des chants de supports de type aggloméré, MDF et contreplaqué

Edge banding trimmer • Kantenhobel • Refilador

Araseur simple

Single sided edge trimmer • Kantenhobel • Refilador simple



Araseur simple Single sided edge trimmer
 Kantenhobel • Refilador simple
 Ref Pdt 650100 2



3 lames Blades • Klängen • Cuchillas
 Ref Pdt 650200 9

Araseur double

Double sided edge trimmer

• Doppel-Klingen-Kantenhobel • Refilador doble



Araseur double Double sided edge trimmer • Doppel-Klingen-Kantenhobel • Refilador doble
 Ref Pdt 650400 3



6 lames Blades • Klängen • Cuchillas
 Ref Pdt 650500 0

► CUISINE | BANDE DE CHANT POUR PLAN DE TRAVAIL

Bandes de chant mélaminées + CPL (stratifiées) > largeurs spéciales

Melamine + CPL edgings > Special widths
Melamin + CPL Kantenumleimer > Spezielle Breiten
Cantos Melamínicos + CPL > Anchos especiales



Ep. ± 0,3 mm

**Non Encollé
(Mélanor)**
non pre-glued • ohne
Schmelzkleber • sin cola

**Pré Encollé
(Mélafix)**
pre-glued • mit Schmelzklebe • con cola



L.

100 ml

1,32 ml

4,20 ml

5 ml

25 ml

100 ml

l.	Code	Décor	Surface	Ref Pdt							
40 mm	F408	Gris moucheté Grey marble • Grau • Gris		-	-	070803 2	070804 9	-	-	-	-
	F5021	Ardoise		-	-	121837 0	121838 7	-	-	-	-
	I264	Noir Black • Schwarz • Negro	L	060161 6	061263 6	-	-	071096 7	074139 8	-	075099 4
	I442	Gris alu alu		-	060204 0	070807 0	-	070523 9	070643 4	-	070723 3
	P099	Blanc White • weiss • blanco	L	061575 0	061084 7	-	-	071172 8	074138 1	075653 8	075128 1
	P099	Blanc White • weiss • blanco	G	-	061312 1	-	-	074550 1	074240 1	-	075447 3
	P104	Seringa Syringa • Seringa	L	-	-	-	-	-	074136 7	-	-
	P150	Blanc White • weiss • blanco	L	061566 8	061055 7	-	-	071093 6	074134 3	071473 6	075096 3
	P150	Blanc White • weiss • blanco	G	-	065716 3	-	-	070020 3	075529 6	-	075203 5
	S0804	Pin nouveaux grisé Pine grey • Grün • Pino gris		-	-	121840 0	121839 4	-	-	-	-
	S0840	Blanco White • Weiss • Blanco		-	-	121831 8	121832 5	-	-	-	-
	S5037	Chêne du quebec Oak • Eiche • Roble		-	-	-	121592 8	-	-	-	-
	S5106	Chêne bastide Oak • Eiche • Roble		-	-	121863 9	121593 5	-	-	-	-
	S5107	Chêne des marais Oak • Eiche • Roble		-	-	-	121594 2	-	-	-	-
	S5108	Textus poivre Grey • Grau • Gris		-	-	-	121595 9	-	-	-	-
	S5120	Chêne topia Oak • Eiche • Roble		-	-	-	121817 2	-	-	-	-
	S5131	Lamello Oak • Eiche • Roble		-	-	121833 2	121834 9	-	-	-	-
	42 mm	S5138	Béton griffé Concrete • Beton • Hormigon		-	-	121862 2	121819 6	-	-	-
S5140		Béton / Basalt Concrete • Beton • Hormigon		-	-	121810 3	121809 7	-	-	-	-
S5183		Béton clair Concrete • Beton • Hormigon		-	-	121841 7	121842 4	-	-	-	-
S5187		Inox brossé alliage Stainless steel • Rostfreier Stahl • Acero inoxidable		-	-	-	121823 3	-	-	-	-
S5188		Caldera Mineral light • Mineral licht • Mineral claro		-	-	-	121821 9	-	-	-	-
S5189		Trieste Mineral dark • Mineral dunkel • Mineral oscuro		-	-	-	121825 7	-	-	-	-
W020		Merisier / Prunier foncé SB Cherry • Kirsche • Cerezo		-	060197 5	-	-	070203 0	070424 9	-	-
W1421		Bouleau / Érable Maple • Ahorn • Arce		-	060104 3	-	-	070204 7	070292 4	-	-
W1572		Wengé / Noyer foncé Wenge		-	-	-	-	070524 6	070642 7	-	070655 7
W1634		Chêne clair scié / Bruges Oak • Eiche • Roble		-	-	070806 3	-	070805 6	-	-	-
W495	Pommier Apple-tree • Apfelbaum • Manzano		-	-	-	-	070146 0	070507 9	-	-	
W522	Hêtre Beech • Buche • Haya		-	060080 0	-	-	070143 9	070427 0	-	070227 6	
W593	Chêne lamellé Oak • Eiche • Roble		-	-	-	-	070202 3	070241 2	-	070522 2	
W937	Hêtre clair - bama Light beech • Buche hell • Haya chiaro		-	-	-	-	070144 6	070299 3	-	070243 6	

Profils aluminium

Aluminium Profiles • Aluminiumprofile • Perfiles de aluminio

L. ± 670 mm



u.c.



- Bien identifier la forme du plan, son épaisseur et son rayon de section.
- L'outil malin pour vous aider à choisir le profil correspondant à votre plan de travail. Pour cela, utilisez les gabarits à l'échelle ci-dessous.

Information for identification of the board, thickness and radius

Informationen zur Klassifizierung der Platte, Stärke und Radius

Identificar la forma de la encimera, su espesor y su radio



2 Quarts de rond
Double radius • Doppel Radius • Radio doble

3 Épaisseurs
3 thicknesses • 3 Stärken
3 Espesores

28 mm
38 mm
58 mm

4 Rayons
4 radius • 4 radius • 4 radios
0 - 2 mm **6 - 8 mm**
3 - 5 mm **9 - 11 mm**



A

B

C

Finition bordure
End cap profile
Endkappenprofil
Terminación Reborde

Jonction bord à bord
Straight run joint profile
Gerades Verbindungprofil
Unión

Jonction d'angle
Corner joint profile
Verbindungprofil
Unión de angulo

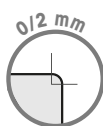

Ep.	28 mm	38 mm	58 mm	28 mm	38 mm	58 mm	28 mm	38 mm	58 mm
-----	-------	-------	-------	-------	-------	-------	-------	-------	-------

Décor	Ref Pdt								
Aluminium Alu	680176 8	680151 5	680154 6	680177 5	680152 2	680155 3	680178 2	680153 9	680156 0
Blanc White • Weiss • Blanco	-	680057 0	-	-	680058 7	-	-	680059 4	-
Noir Black • Schwarz • Negro	-	680060 0	-	-	680061 7	-	-	680062 4	-

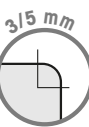
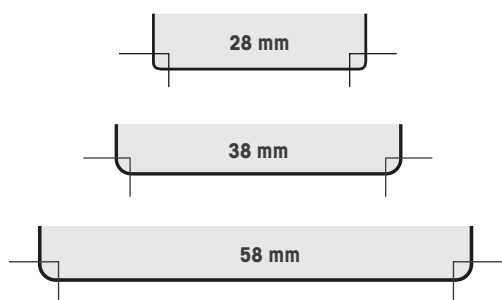

Ep.	28 mm	38 mm	28 mm	38 mm	28 mm	38 mm
-----	-------	-------	-------	-------	-------	-------

Décor	Ref Pdt					
Aluminium Alu	680106 5	680100 3	680124 9	680118 8	680115 7	680109 6
Blanc White • Weiss • Blanco	680107 2	680101 0	680125 6	680119 5	680116 4	680110 2
Noir Black • Schwarz • Negro	680108 9	680102 7	680126 3	680120 1	680117 1	680111 9

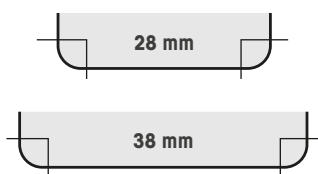

Ep.	28 mm	38 mm	28 mm	38 mm	28 mm	38 mm
-----	-------	-------	-------	-------	-------	-------

Décor	Ref Pdt					
Aluminium Alu	680145 4	680014 3	680147 8	680016 7	680146 1	680015 0
Blanc White • Weiss • Blanco	680148 5	680017 4	680149 2	680020 4	680150 8	680023 5

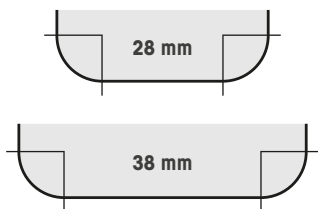

Ep.	28 mm	38 mm	28 mm	38 mm	28 mm	38 mm
-----	-------	-------	-------	-------	-------	-------

Décor	Ref Pdt					
Aluminium Alu	680002 0	680112 6	680008 2	680113 3	680011 2	680114 0
Blanc White • Weiss • Blanco	680004 4	680142 3	-	680143 0	-	680144 7

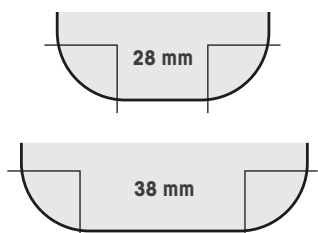

* Jusqu'à épaisseur du stock

► CUISINE | CRÉDENCE - PLAN DE TRAVAIL



Support de snack Breakfast bar • Snack Bodenträger • Soporte de estante snack



• Pour créer un espace bar/snack convivial ; une console desserte dans une cuisine ouverte, ou simplement pour disposer de plus d'espace de travail

To create a friendly bar / snack area , a service shelf in an open kitchen or simply to have more workspace

Um eine freundliche Bar / Snack-Bereich, ein Service Regal in einer offenen Küche zu schaffen oder einfach, um mehr Arbeitsfläche haben

Para crear un espacio barra / snack agradable , un estante de servicio en una cocina abierta, o simplemente para tener más espacio de trabajo.

Support de snack Zen



ALU ANODISÉ



x 2

U.C.

x 5

- Pied mono bloc
- Matériau : aluminium anodisé
- Vis inox fournies

Monoblock stand • Integralträger • Soporte monobloque.

Anodized aluminum • Eloxiertem Aluminium • Aluminio anodizado.

Stainless steel screws provided • Mit Edelstahl-Schrauben • Con Tornillos de acero inoxidable.

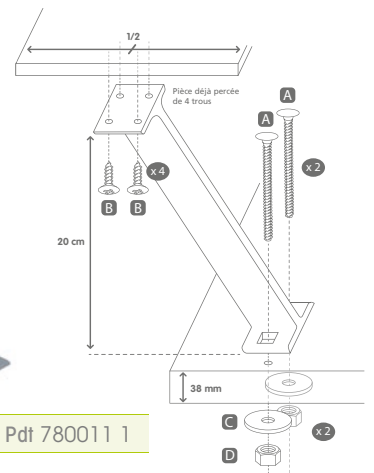

Ref Pdt 780011 1

Support de snack incliné (21 cm LUX - finition inox brossé)



ACIER



x 2

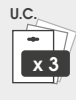

x 3

- Hauteur posé : 21 cm
- Quincaillerie
- Notice de pose fournies
- Discret et Design

Installed height • Montagehöhe • Altura de instalación

Hardware provided • Kleinteile inkl • Herrajes incluidos

Fitting instructions included • Mit Montageanleitung • Instrucciones de montaje incluidas

Discreet and stylish • Formschön und diskret • Discreto y de diseño

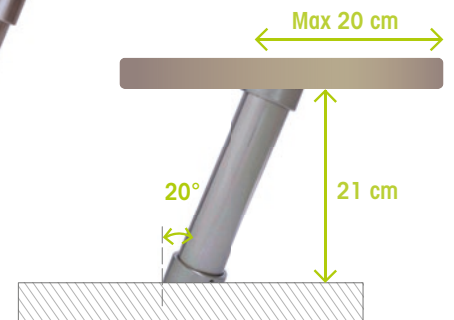

Ref Pdt 780033 3

Jambage

Pour réaliser une zone repas en prolongement de votre plan de travail.



ACIER

x 1



x 3

Blanc
White • Weiss •
Blanco

Anthracite
Grey • Grau •
Grís

- Hauteur : 85 à 86 cm
- Largeur : 40 cm
- Epaisseur : 5 cm

Ref Pdt 780049 4

Ref Pdt 780050 0

To create a dining area as an extension of your work plan.

Erstellen eines Essbereichs als Erweiterung Ihres Arbeitsplans.

Para crear un área de comedor como una extensión de su plan de trabajo.

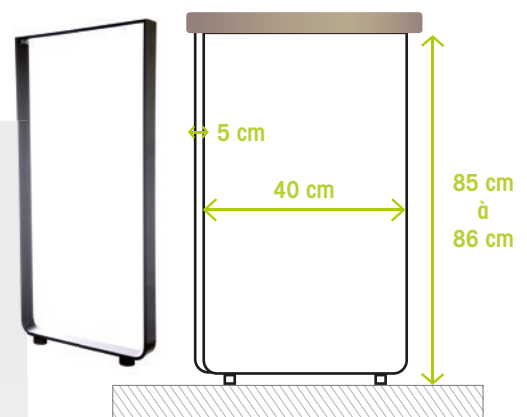

Slim Kook

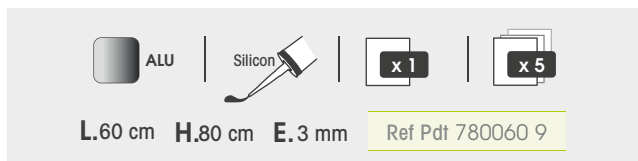

- ✓ Facile à installer
- ✓ Se coupe facilement
- ✓ Préserve la propreté des murs
- ✓ 2 modes de fixation : collage ou fixation murale

Easy to install • Einfach zu installieren • Instalacion fácil
 Easy to cut • Leicht zu schneiden • Cortar facilmente
 Maintains walls clean • Behält die Sauberkeit der Wände •
 Mantiene las paredes limpias
 2 Möglichkeiten der Montage: Klebstoff-oder Wandmontage
 • 2 possible ways of mounting: adhesive or wall mounting • 2
 modos posibles de montaje: montaje adhesivo o en la pared

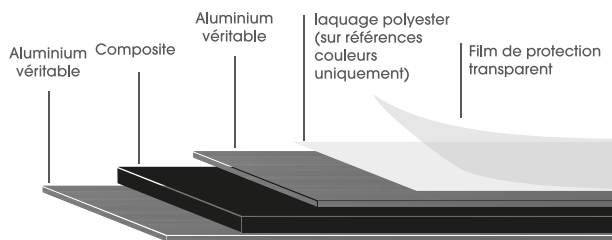

Crédence basse

Stainless steel backsplash tiles •
 Edelstahl-Spritzschutzplatten • Placas murales
 de cocina

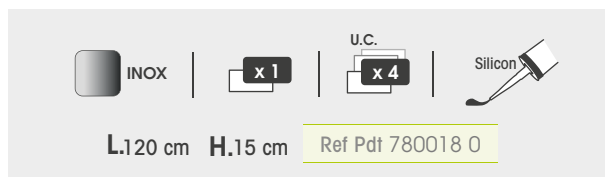

- ✓ Esthétique : accord parfait avec le fond de hotte inox
 - ✓ Solution économique
- Good value for money • Effiziente Lösung
 Solución económica

Fond de hotte

Stainless steel backsplash tiles • Edelstahl-
 Spritzschutzplatten • Placas murales de cocina

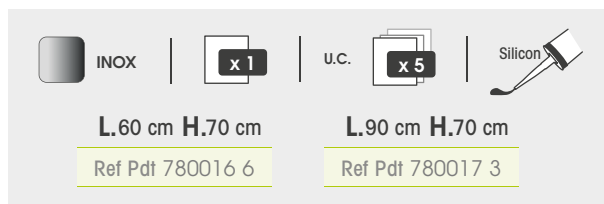

- ✓ Facile à installer
 - ✓ Préserve la propreté des murs
 - ✓ Se pose derrière tout type de plaque de cuisson
- Easy to install • Einfach zu installieren • Instalacion fácil.
 Maintains walls clean • Behält die Sauberkeit der Wände •
 Mantiene las paredes limpias.
 Behind any type of hob • Hinter jedem Kochfeld • Detrás
 de cualquier tipo de encimera

► CUISINE | CRÉDENCE - PLAN DE TRAVAIL



Réglette LED sans fil à détection de mouvement

Wireless LED light with motion sensor
Wireless-LED-Licht mit Bewegungssensor
Luz LED inalámbrica con sensor de movimiento

LED BLANC | L. 19 cm H. 3 cm Ep. 1,6 cm

x 1 | U.C. x 5 | Ref Pdt 780040 1



- ✓ Fixation simple : languette aimantée et adhésive
 - ✓ Sans fil - Fonctionne avec 4 piles AAA (non incluses)
 - ✓ Zone de détection 140° et jusqu'à 5m en situation d'obscurité
 - ✓ Basse consommation - luminosité : 30 Lumens
- Easy to install (magnetic and adhesive backing) •
Einfache Befestigung: Magnetlasche mit Haftschicht •
Fijación simple: lengüeta imantada y adhesiva

Wireless. Uses 4 x AAA batteries (not included) • Drahtlos. Versorgung durch 4 Batterien AAA (kein Lieferumfang) • Inalámbrica. Funciona con 4 pilas AAA (no incluidas)

Sensor range of 140° and up to 5 m in darkness • Leuchtbereich 140°, bei Dunkelheit bis zu 5 m • Zona de detección de 140° y hasta 5 m en la oscuridad

Low power consumption. Brightness: 30 lm (lumens) • Niedriger Verbrauch. Lichtstärke: 30 lm (Lumen) • Bajo consumo. Luminosidad: 30 lm (lúmenes)

Profil de finition de crédence

backsplash finishing profile
Abschlussprofil für Küchenwand
Perfil de acabado pared de cocina

ALU ANODISÉ | L. 3,15 m | x 1 | U.C. x 8 | Silicon

• **Matériau : aluminium anodisé**
Anodized aluminum • Eloxiertem aluminium • Aluminio anodizado

• De 8 à 10 mm | Ref Pdt 670209 6

- ✓ Simple et rapide à poser
- ✓ Esthétique et durable

Quick and easy to install • Einfach und schnell zu installieren • Sencillo e instalación rápida

Beautiful and sustainable • Schön und nachhaltig • Estético y sostenible



Top protect Baguettes repose plat

Trivet blades • Topfuntersetzer Klingen
Tiras salvamantel

INOX | L. 25 cm H. 1 cm Ep. 2,5 mm | x 5

U.C. x 5 | **Fixation : auto adhésif**
Self adhesive • Verglasung • Autoadhesivo

Ref Pdt 780023 4

- ✓ Prêt à poser
- ✓ Pour tout type de plan de travail
- ✓ Gabarit de pose inclus

Ready to install • Bereit zu installieren • Listo para instalar

For any kind of working top • Für jede mögliche Küchenarbeitsplatte • Para todas las encimeras de cocina

Installation template included • Installation Vorlage enthalten • Plantilla de instalación incluido



Canules

Cannulas • Kanülen • Cànulas



Ref Pdt 780012 8

✓ Compatible avec toutes les cartouches (silicone, colle, mastic)

Compatible with all cartridges (silicone, glu, putty, ...)
Kompatibel mit allen Patronen (Silikon, Leim, Kitt, ...)
Compatible con todos los cartuchos (silicona, pegamento, masilla, ...)



Profil de protection Alu de plan de travail

Profile for the protection Alu of kitchen working tops
Schutzprofil Alu für Küchenarbeitsplatten
Perfil para la protección Alu de encimeras de cocina

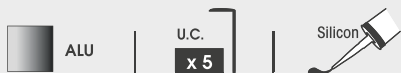

L. 3,15 ml H. 38 mm Ep. 11 mm

Ref Pdt 780024 1

L. 3,15 ml H. 28 mm Ep. 11 mm

Ref Pdt 780032 6

- Pour plan de travail de 28 ou 38 mm d'épaisseur
- Pour plan de travail de rayon 0 à 9 mm

For 28 or 38mm working top • Für 28 oder 38 mm Arbeitsplatte • Por encimeras de 28 o 38 mm

For working top with 0-9mm radius • Für Arbeitsplatte mit 0-9mm Radius • Por encimeras con radio de 0 o 9 mm



✓ Idéal neuf et rénovation

Perfect for new kitchen or renovation
Perfekt für neue Küche oder Renovierung
Perfecto para cocina nueva o renovación

Pare vapeur

Protective sheet • Pelicula de proteccion
Schutzfolie

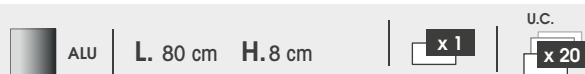

- Adhésif • Pose facile • Discret

Self adhesive • Easy to install • Discreet
Selbstklebend • Einfache Installation • Diskret
Auto adhesivo • Instalacion Facil • Discreto

Ref Pdt 780019 7



Profil pour îlot de cuisine

Kitchen island junction trim
Küchenverbindungsprofil
Perfil de union para cocinas

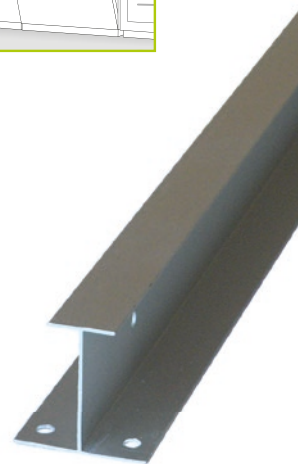
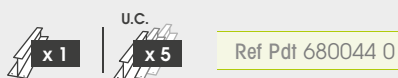
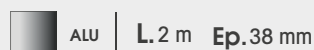

► CUISINE | ÉTANCHÉITÉ



Profil d'étanchéité de cuisine

Kitchen sealing profile "PREA-D"
 • Küchenabdichtungsprofil
 "PREA-D" • Perfil de sellado de
 cocina "PREA-D"

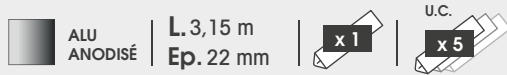
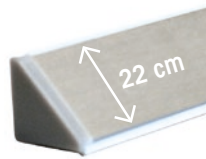

Matériau : plastique + aluminium Ref Pdt 670211 9

Kit de finition pour profil PREA-D

Accessory set for "PREA-D" backsplash profile
 Zubehör für Küchenprofil "PREA-D"
 Accesorios para perfil de cocina "PREA-D"

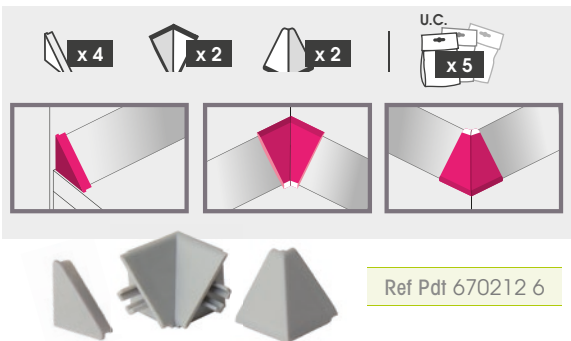

Ref Pdt 670212 6

Joint plastique

Sealing tape • Wasserdichtung
 Junta de estanqueidad

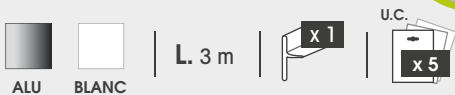

Pour la réalisation de joint d'étanchéité
 entre le plan de travail et le mur.

To make a seal between the working top and wall
 • Eine Dichtung zwischen der Arbeitsplatte und
 Wand erzielen • Para lograr un sellado hermético
 entre la encimera y la pared



	Ref Pdt
Blanc	780001 2
Gris Alu	780007 4

- ✓ Recoupe facile
- ✓ Discret
- ✓ Remplace avantageusement la silicone
- ✓ Épouse la forme du support

Easy to cut • Leicht zu schneiden • Corte fácil
 Discret • Diskret • Discreto
 Replaces silicone • Ersetzt Silikon • Reemplaza
 ventajosamente la silicona
 Conforms to the contours of the support • Passt sich
 der Form des Trägers • Se adapta a la forma de la
 base

Profils d'étanchéité XS C et XS B

Sealing profiles • Dichtungsprofile • Perfiles de sellado



- ✓ Livré avec 4 embouts droits de finition + 2 embouts rentrants + 2 embouts sortants

Delivered with 4 flat stamps + "2 out" pieces + "2 in" pieces
 • Mit 4 Abschlusskappen inklusive + 2 Aussenecke + 2
 Innenecke • Entregado con 4 topos laterales + 2 topos de
 ángulo saliente + 2 topos de ángulo entrante

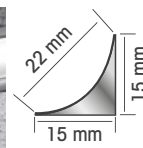

XS C	Ref Pdt
Aluminium	670205 8
Blanc	670214 0
Noir	670213 3

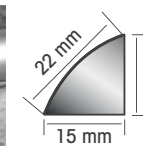

XS B	Ref Pdt
Aluminium	670206 5

Mastiplast

Sealing tape • Wasserdichtung
 Junta de estanqueidad



- Cuisine, salle de bain, vitrage
- Fixation : auto adhésif

Ref Pdt 780002 9

Sealing tape : self adhesive, multi-use
 Dichtung für : Verglasung, Küchen, Badezimmer
 Junta de estanqueidad :
 autoadhesivo, multiuso



- ✓ Facile à poser
- ✓ Étanche
- ✓ Propre

Easy to set • watertight and
 clean • Einfach • Wasserdicht •
 Sauber • Instalación sencilla •
 estanque • limpio.



BIEN
 VU



Ref Pdt 940019 7

Raccords de plinthes agglo MDF

Fittings for skirting boards • Anschlüsse für Sockelleisten • Unión para rodapiés agglo

H.150 mm
Ep.16/19 mm



Recoupable en hauteur

Se puede cortar en altura
Can be cut in height
Kann in der Höhe geschnitten werden

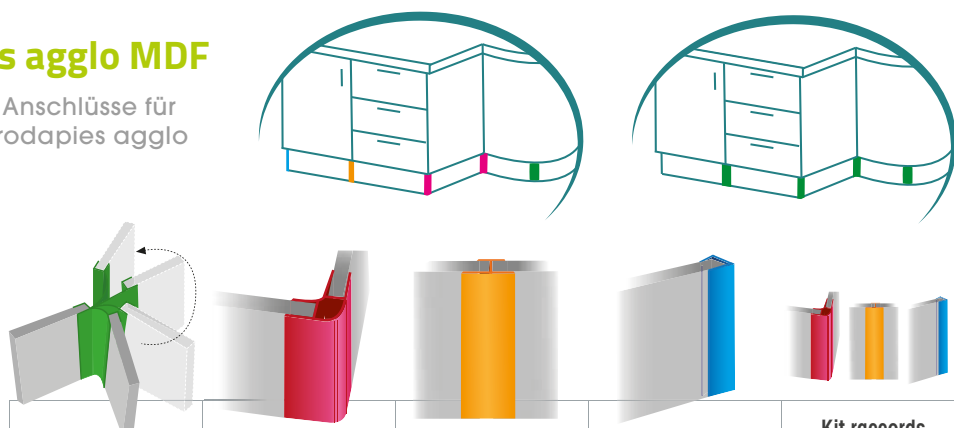

Angle Universel Universal corner Universal-Winkel Angulo universal	Angle Droit Angle Junction Winkelanschlussstück Angulo recto	Jonction Droite(H) Straight Junction Gerade Verbindung Union Recta	Profil de Finition(U) End cap profile Endkappen Profil Perfil de acabado	Kit raccords de Plinthe Fittings for skirting boards • Anschlüsse für Sockelleisten • Kit uniones de rodapiés
UNIT x 4	UNIT x 4	UNIT x 4	UNIT x 4	2U+2H+2 angles droits

Décor	Ref Pdt				
Gris alu Alu	790024 8	790027 9	790030 9	790033 0	790036 1
Blanc White • Weiss • Blanco	790025 5	790028 6	790031 6	790034 7	790037 8
Noir Black • Schwarz • Negro	790026 2	790029 3	790032 3	790035 4	790038 5

Support micro-ondes

Microwave wall bracket
Wandhalterung für Mikrowelle
Soporte de pared para microondas

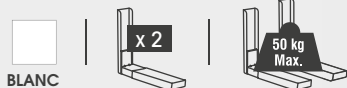

Variable de 80 x 440 mm
S'adapte à toutes les profondeurs
H. 250 L. 45 mm

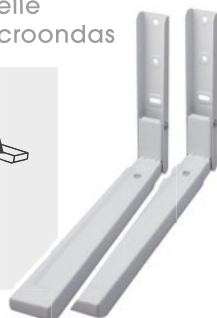

Ref Pdt 780021 0

Cache vis

Screw hider • Selbstklebende Abdeckkappen • Tapas autoadhesivas



Ø 13 mm

Fixation : auto adhésif

Self adhesive
Selbstklebende
Autoadhesivas



	Ref Pdt
Blanc	650600 7
Hêtre*	650602 1
Gris	650605 2
Noir	650604 5

Profil U transparent

U transparent profile • U transparent Profil
Perfil U transparente

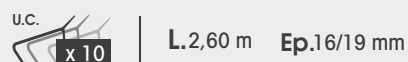

Pour l'étanchéité et la protection des plinthes de cuisine



Ref Pdt 670074 0



Freins de porte

Kitchen door brake • Küchentür Bremse • Amortiguador de puerta de cocina



Ref Pdt 780009 8



Ref Pdt 780010 4

Cuisine, meuble

Kitchen, furnitue
Küchen, Möbel
Cocina, Mueble

✓ Fini les portes qui claquent !

No more slamming doors ! • Nie mehr Zuschlagen von Türen !
No mas puertas golpeando !

* Jusqu'à épaisseur du stock

SOL ET MUR | Ô MUR DÉCORATION



Changer votre déco n'a jamais été aussi simple et rapide !

Ô MUR est un système de fixation unique et innovant qui vous permet de poser tous les sols clipsables au mur. Ce système ingénieux, très facile à mettre en œuvre, vous offre de nombreuses possibilités créatives pour décorer et aménager votre intérieur.

Change your decoration is easier and faster than ever ! Ô MUR is a unique and innovative fixing system, which allows you to lay clip floors on the wall. This ingenious system, very easy to set up, offers you numerous creative possibilities to decorate, renovate and fit out your interior • Ein Dekorwechsel war noch nie so einfach! Ô MUR ist ein einzigartiges und innovatives Befestigungssystem, mit dem Sie alle verklickbaren Böden an der Wand verlegen können. Dieses geniale System, sehr einfach einsetzbar, bietet Ihnen viele kreative Möglichkeiten, um Ihr Zuhause zu dekorieren, zu renovieren und zu gestalten • ¡Modificar su decoración nunca fue tan fácil y rápido! Ô MUR es un sistema de fijación único e innovador que le permite colocar todos los suelos con sistema clips a la pared. Este ingenioso sistema, muy fácil de poner en práctica, le ofrece numerosas posibilidades creativas para decorar, renovar y acondicionar su interior.



www.o-mur.com



- ✓ Un système breveté unique et innovant
- ✓ Décorer
- ✓ Compatible avec tous les supports (plaque de plâtre, brique, parpaing et/ou bois)
- ✓ Facile et rapide
- ✓ Compatible avec tous les parquets clipsables
- ✓ Pour les parquets d'une épaisseur entre 6 et 16 mm

A unique and innovative patented system - Decorate - Compatible with all media - Easy and fast - For all clip-on parquet floors with a thickness between 6mm and 16mm • Ein einzigartiges und innovatives patentiertes System - Dekorieren - Kompatibel mit allen Medien - Einfach und schnell - Für alle aufsteckbaren Parkettböden mit einer Dicke von 6mm bis 16mm • Un sistema patentado único e innovador - Decorar - Compatible con todos los soportes - Fácil y rápido - Para todos los suelos de parquet de clip con un grosor entre 6 mm y 16 mm



Rails à fixer au mur
Studs / Schienen
Carriles



Clips de départ/arrêt
Start / Stop Clips
Anfangs- und Endclips
Clips de partida y parada

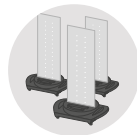

Clips de connexion
Connexion clips
Verbindungsclips
Clips de conexión

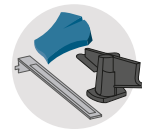

Clé de montage, Multi Tool et rasoir
Multitools + installation key + razor
Multitools + Montageschlüssel + Cutter
llave de montaje + multitool + navaja de acabado

	Ref Pdt	U.C	Présentoir
Combo pack	820000 2	x 10	30
Sachet de 6 rails	820004 0	x 10	10
Sachet de 8 clips D/A - départ/arrêt (+ 12 pastilles adhésives)	820002 6	x 10	10
Sachet de 18 clips de connexion	820001 9	x 20	20
Toolkit ou kit de pose	820003 3	x 20	20

Kal Stop

Cale de montage plastique

Plastic lifting wedge
Kunststoffhebekeil • Cuña de elevación de plástico

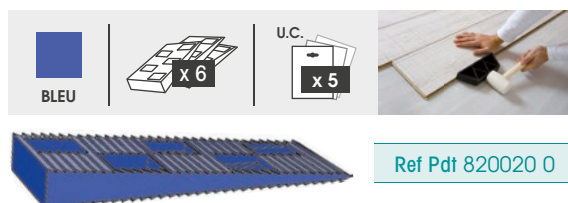

Ref Pdt 820020 0

Présentoir

BIEN VU



Ref Pdt 820005 7

Rénover et aménager vos combles grâce au système Ô MUR RÉNOVATION !

Le système Ô MUR RÉNOVATION est idéal pour tous vos travaux de rénovation afin d'aménager les combles. Les rails en aluminium sont parfaitement adaptés pour une pose sous les toits, et se fixent directement sur les chevrons. La pose du système Ô MUR RÉNOVATION est aussi facile et rapide que la pose d'un revêtement de sol pour une rénovation chaleureuse et moderne de votre intérieur.

RENOVATION vate and fit out your attic thanks to the Ô MUR RENOVIATION system ! The Ô MUR RENOVIATION system is ideal for all RENOVIATION vation work to fit out the attic. The installation of the Ô MUR RENOVIATION system is as easy and quick as the installation of a covering • RENOVIATION vieren und einrichten Sie Ihren Dachboden mit dem Ô MUR RENOVIATION System. ! Das System Ô MUR RENOVIATION ist ideal für alle RENOVIATION vierungsarbeiten zur Ausstattung des Dachgeschosses. Die Montage des Ô MUR RENOVIATION Systems ist so einfach und schnell wie die Montage einer Abdeckung • RENOVIATION var y acondicionar su ático gracias al sistema Ô MUR RENOVIATION ! El sistema Ô MUR RENOVIATION es ideal para todos los trabajos de RENOVIATION vación para acondicionar el ático. La instalación del sistema Ô MUR RENOVIATION es tan fácil y rápida como la instalación de un revestimiento.



www.o-mur.com

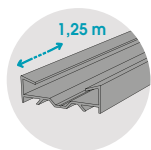

Rails à fixer Alu
Aluminium rails
Schienen aus Aluminium
Rieles de aluminio

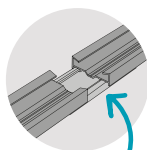

Jonctions
Aluminium rail connection
Schienenkonformes Aluminium
Conexión ferroviaria de aluminio



Clips de départ / arrêt +
Start / Stop Clips
Anfangs- und Endclips
Clips de partida y parada

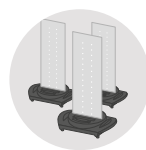

Clips de connexion
Connexion clips
Verbindungsclips
Clips de conexión

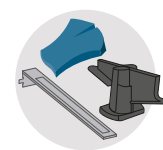

Clé de montage, Multi Tool et rasoir
Multitools + installation key + razor
Multitools + Montageschlüssel + Cutter / llave
de montaje + multitool + navaja de acabado

	Rail alu 1,25 m	Jonctions 7 cm (sachet de 6)	Clips D/A 8 clips + 12 pastilles	18 Clips de connexions C	Toolkit ou kit de pose	30 Vis et chevilles
Ref Pdt	820014 9	820015 6	820017 0	820001 9	820003 3	820006 4
U.C						

Accessoires complémentaires

Additional accessories • Weiteres Zubehör • Accesorios adicionales

NivÔ EasyFix

Pince le support, mains libres

Pinch the holder, hands-free
Drücken Sie den Halter, freihändig
Pellizcar el soporte, manos libres



u.c. **x10**

Ref Pdt **820018 7**

Click Ô MUR

Panneau clipsable blanc - Prêt à peindre, hydrofuge, se découpe facilement

Ready to paint, waterproof, easily cut
Lackierfertig, wasserdicht, leicht zu schneiden
Listo para pintar, impermeable, fácil de cortar



ℓ. 30 cm L. 120 cm Ep. 8 mm

u.c. **x1**
Paquet de 4 lames

Ref Pdt **820007 1**

Ô MUR Profil 3 in 1

Profil de finition

3 in 1 finishing profile
3 in 1 Abschlussprofil
Perfil de acabado 3 en 1



	Ref Pdt
Blanc glossy	820008 8
Noir satiné	820009 5
Gold métallisé	820010 1
Argent métallisé	820011 8
Bronze métallisé	820012 5
Blanc à peindre	820013 2

ℓ. 5 cm L. 135 cm Ep. 2 mm

u.c. **x1**
Fixation adhésive
Sachet de 6

SOL ET MUR

Plaque Composite Aluminium

Aluminum Composite Panel
Aluminium-Verbundplatte
Panel de aluminio y
composite

Décor	Ref Pdt
Blanc White • weiss • blanco	780029 6
Aluminium brossé Alu	780028 9
Champagne brossé	780038 8
Black Silver	780039 5
Brosse Noir	780058 6
Pierre de Lave	780059 3



AVANT
Before • Vorher • Antes

APRÈS
After • Nachher • Después

L. 120 cm H. 80 cm Ep. 3 mm

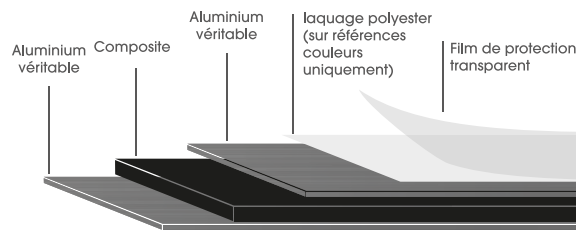
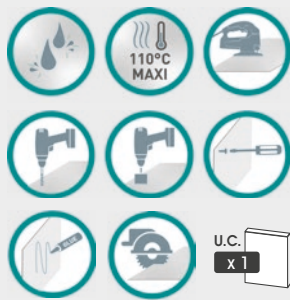

Présentoir

MÉTAL | u.c. x 50



Ref Pdt 940157 6

✓ Léger ✓ Facile à découper ✓ Facile à fixer

Light • Leicht • Ligero / Easy to cut • Einfach zu schneiden • Fácil de cortar / Easy to install • Einfach zu befestigen • Fácil de instalar

Profils de finition pour plaque composite alu

L. 122 cm Ep. 3 mm | u.c. x 12

Profil de finition

End cap profile • Endkappenprofil
• Terminación Reborde

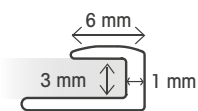

Ref Pdt 780041 8

Profil de jonction bord à bord

Straight run joint profile • Gerades
Verbindungsprofil • Unión

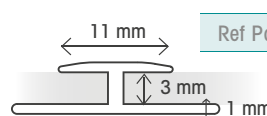

Ref Pdt 780042 5

Profil d'angle

Corner joint profile Verbindungsprofil
• Unión de angulo

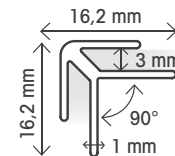

Ref Pdt 780044 9

Clips à lambris

Panelling hooks • Täferkrallen • Grapas para frisos

Clips pour lambris en pose murale

CLIPS + POINTES

• HOOKS + NAILS • HAKEN +
NÄGELN • GRAPAS + CLAVOS



		Pour lambris d'épaisseur de	±	m ²	Ref Pdt
Lambris bois Panelling wood • Holz Täfer - Holz • Friso Madera	3 mm	10-12 mm	100	5	740100 4
			250	10	740101 1
	4 mm	13-16 mm	250	10	740106 6
	5 mm	18-21 mm	200	10	740105 9
Lambris PVC Panelling PVC Holz Täfer PVC • Friso PVC	1 mm	6-12 mm	250	10	740103 5
Lambris MDF Panelling MDF • Holz Täfer MDF • Friso MDF	1,6 mm	6-12 mm	250	10	740104 2

Clips pour lambris en pose plafond

CLIPS + VIS

• HOOKS + SCREW • HAKEN +
SCHAUBE • GRAPAS + TORNILLOS



	Pour lambris d'épaisseur de	±	Ref Pdt
3 mm	10-12 mm	100	740107 3

Invisible après pose

Invisible after installation
Unsichtbar nach der Installation
Invisible después de la instalación

Smart Profile

Profil PVC adhésif en rouleau ± 2,60 m

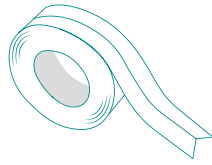

- ✓ **Produit multifonctions : habillage, finition, décoration, rénovation**
- ✓ **Profil PVC : Pour tous les types d'angles, même les plus complexes**
- ✓ **Chant livré plat mais avec rainures de préformage**
- ✓ **À plier**
- ✓ **Adhésivé**



PVC profile : For all types of angles, even the most complex • Flat but Preformed • To be folded • Adhesive
 PVC-Profil: Für alle Arten von Winkeln, auch für die komplexesten • Flach, aber vorgeformt • Zu falten • Kleber
 Perfil de PVC : Para todo tipo de ángulos, incluso los más complejos • Plano pero preformado • Para ser plegado • Adhesivo

4 formes

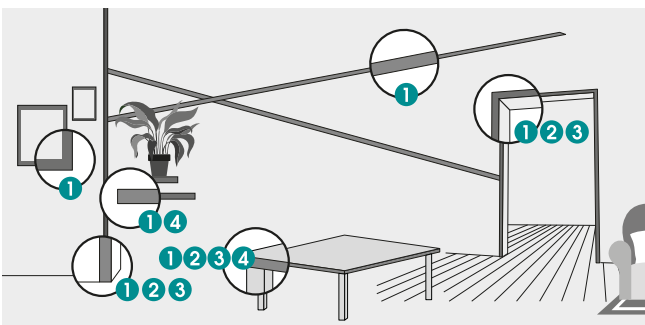
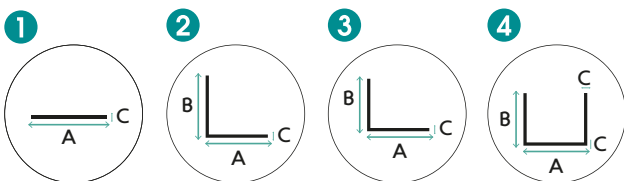

	Dimensions (cm) A x B x C	Ref Pdt	U.C
1 Champlat «I» I-platte strip • I flat profile • Perfil plano I I-Flachstange	3 x 0,04	840006 8	10
2 Cornière égale «L» L-hoekprofiel • L equal angle profile • Perfil L igual • L-Winkelprofil gleichschenkelig	1,5 x 1,5 x 0,04	840002 0	10
	2 x 2 x 0,04	840001 3	8
	2,5 x 2,5 x 0,04	840000 6	7
3 Cornière inégale «L» L-profiel L • Unequal angle profile • Perfil L desigual • L-Winkelprofil ungleichschenkelig	2 x 1 x 0,04	840005 1	10
	3 x 1,5 x 0,04	840003 7	8
	4 x 1 x 0,04	840004 4	8
4 Profil «U» U-profiel • U profile • Perfil U • U-Profil	1 x 1 x 0,04	840009 9	10
	1,5 x 1,5 x 0,04	840007 5	7
	2 x 1 x 0,04	840008 2	8

SOL ET MUR



Nez de cloison

Wall partition edge protection
Wandkantenschutz • Protección de bordes



- ✓ Masque les éventuels éclats ou imperfections
- ✓ Simple à poser

Mask any splinters or imperfections • Easy to Install
Maskieren Sie Splitter oder Unvollkommenheiten • Simple de preguntar
Enmascarar astillas o imperfecciones • Simple de preguntar

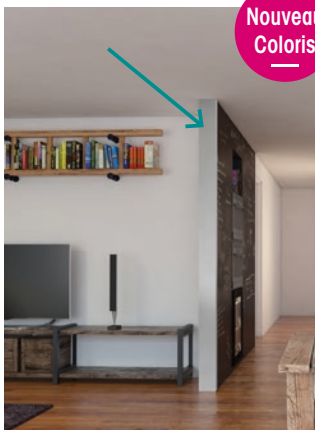

Nouveau Coloris

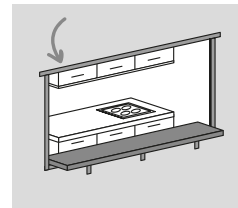
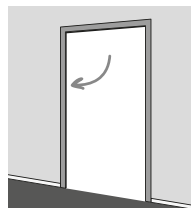
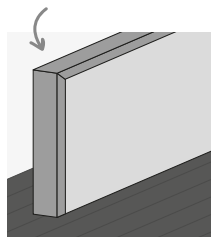
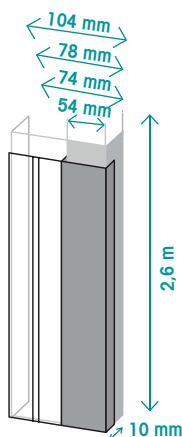

- Vissage ou collage
- Produit disponible en différentes largeurs

Screwing or gluing • Product available in different widths • Verschrauben oder Kleben
• Produkt in verschiedenen Breiten erhältlich
• Atornillar o pegar • Producto disponible en diferentes anchos



	U.C.	Ref Pdt		
		Alu	Blanc	Noir
2.6 m x 54 mm x 10 mm	10	810000 5	810004 3	810008 1
2.6 m x 74 mm x 10 mm	10	810001 2	810005 0	810009 8
2.6 m x 78 mm x 10 mm	10	810002 9	810006 7	810010 4
2.6 m x 104 mm x 10 mm	5	810003 6	810007 4	810011 1

Plinthes cache fil PVC

Plastic skirting board • Kunststoff-Sockelleiste • Rodapie cubrecable PVC

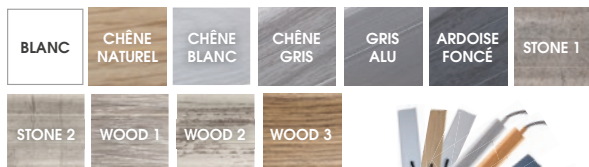

L. 2,5 m H. 6 cm Ep. 1,2 cm | u.c. x 10

À coller ou visser

Glue or screw mounted • Montage mit Leim oder Schrauben • Se instala con cola o con tornillos

	Ref Pdt
Blanc	790000 2
Chêne naturel	790001 9
Chêne blanc	790002 6
Chêne gris	790042 2
Gris alu	790041 5
Ardoise foncé	790045 3
Wood 1	790061 3
Wood 2	790062 0
Wood 3	790067 5
Stone 1	790071 2
Stone 2	790072 9

Kit de finition+ pour plinthes Pass'Fil

Assembling and finitn kit
• Montage-und fertigungszubehöre
• Kit de acabado

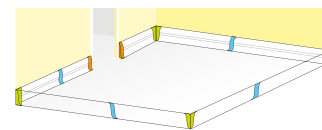

Kit « tout en un » : 2 embouts droits + 4 angles rentrants + 2 angles sortants + 4 jonctions droites

Kit : 2 endcaps + 2 outward angles + 4 straight junctions + 4 inward angle

Kit : 2 Endkappen + 2 Außen Winkeln + 4 gerade Kreuzungen + 4 inner winkln

Kit : 2 tapas + 2 angulos abiertos + 4 uniones rectas + 4 angulo cerrado

KIT : nouvelle composition

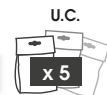

	Ref Pdt
Blanc	790089 7
Chêne naturel	790090 3
Chêne blanc	790091 0
Chêne gris	790092 7
Gris alu	790093 4
Ardoise foncé	790094 1
Wood 1	790095 8
Wood 2	790096 5
Wood 3	790097 2
Stone 1	790098 9
Stone 2	790099 6

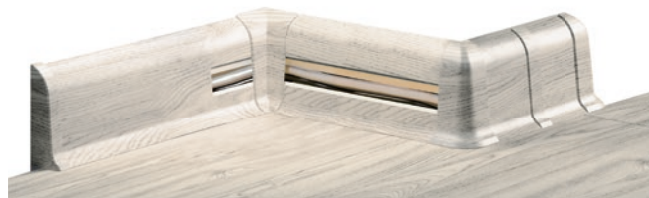
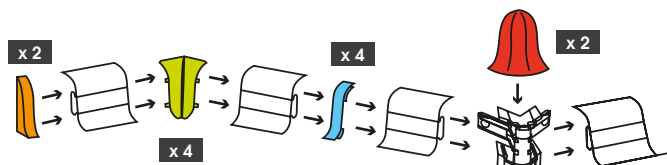

Cubix « Assemblez vos idées »

Cubix «Assemble your ideas» • Cubix «Bauen Sie Ihre Ideen»
• Cubix «monten vuestras ideas»

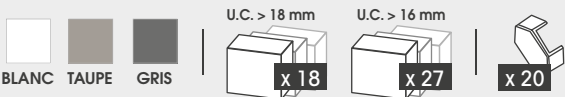

Pour la création de meubles sur-mesure
To create tailor-made furniture
Um ihre eigene spezifische Möbel zu erstellen
Para la creación de muebles a medida



- ✓ Facile et rapide à mettre en œuvre
- ✓ Design et discret
- ✓ Économique
- ✓ Créer des meubles sur mesure
- ✓ Combinaisons à l'infini
- ✓ Look contemporain
- ✓ Une seule pièce pour toutes les combinaisons

Assembling ideas • Montieren Sie Ihre Ideen • Ensamble sus ideas
Made-to-measure furniture by you • Für Möbelbau nach Maß • Para crear muebles a medida
Quick and easy to install • Unkomplizierte und schnelle Montage • Sencillo y rápido de montar
Discreet and stylish • Diskretes Design • Discreto y de diseño
Economical • Kostensparend • Económico
Create made-to-measure furniture • Möbelbau nach Maß Cree muebles a medida
Infinite combinations • Unendlich viele Kombinationen • Infinitas combinaciones
Contemporary look • Moderner Look • Estilo contemporáneo
one piece for all combinations
einteilig für alle Kombinationen
una sola pieza para todas las combinaciones

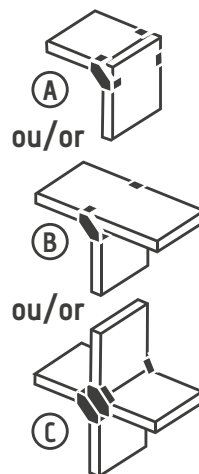
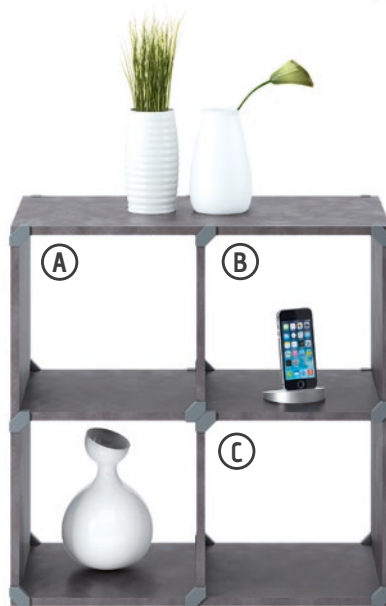
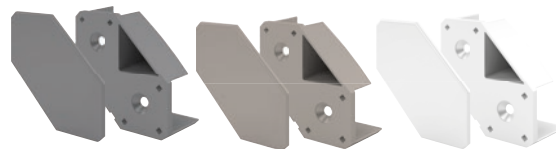

		Ref Pdt
16 mm	Blanc	3700536897637
	Taupe	3700536897651
	Gris	3700536897631
18 mm	Blanc	3700536897606
	Taupe	3700536897620
	Gris	3700536897613



BIEN VU



144 cm
122 cm
38 cm
37 cm
46.5 cm
23.5 cm
37 cm
35 cm



Le flashcode sur la boîte permet d'accéder au site cubix.life et à la vidéo de démonstration.

Ref Pdt 940151 4



Cubix Mix



• Pièce complémentaire à CUBIX pour tablettes de 18/19mm

Complementary part to CUBIX for 18/19mm shelves
Ergänzungsteil zu CUBIX für 18/19mm Fachböden
Pieza complementaria a CUBIX para estanterías de 18/19mm

Pour ajouter un fond au meuble !



		Ref Pdt
18 mm	Blanc	3700536897668
	Taupe	3700536897675
	Gris	3700536897682



Taquets d'assemblage

Wedges for panel assembling • Verbindungskeil für Sperrholzplatten • Tacos de ensamblaje para paneles

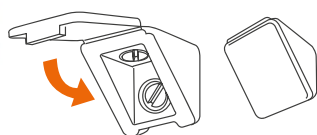

	8 Taquets	16 Taquets	32 Taquets	4 Taquets double largeur	8 Taquets
	8 wedges 8 keile 8 tacos	16 wedges 16 keile 16 tacos	32 wedges 32 keile 32 tacos	4 double width wedges 4 doppelbreite keile 4 tacos doble anchura	8 wedges 8 keile 8 tacos
U.C.	x 10	x 16	x 10	x 10	x 400
Décor	Ref Pdt				
Blanc • White • weiss • blanco	740025 0	740028 1	740046 5	740048 9	740026 7
Taupe	740008 3	740009 0	740010 6	-	-
Gris alu • Grey alu • Grau alu • Gris alu	740056 4	-	740057 1	-	-

Assemblage de tablettes, panneaux, étagères

Assembling of shelves and panels
Befestigung von Fachböden, Paneelen und Regalen
Fijación de estantes y paneles



- ✓ Fixation invisible
- ✓ Permet d'assembler meuble, placard, dressing facilement et rapidement

Concealed fixing • Verdeckte Befestigung
Fijación oculta

Used to assemble furniture and wardrobes quickly and easily • Um Möbel und Schränke schnell und einfach zusammenzubauen • Se utiliza para montar muebles y armarios rápidamente y fácilmente.

Tourillons

Dowels • Dübel • Clavijas



Ø 8 mm x 40

Ref Pdt 780013 5



Ø 10 mm x 30

Ref Pdt 780014 2

Assemblage de tablettes, panneaux, étagères

Assembling of shelves and panels
• Befestigung von Fachböden, Paneelen und Regalen • Fijacion de estantes y panels



Bande anti-dérapante

Anti-slip tape • Antirutschband
Cinta antideslizante



L. 6 ml l. 25 mm

Ref Pdt 742025 8

- Bande auto-adhésive
- Pour marches d'escalier

Adhesive tape • Klebeband • Cinta adhesiva
For stairs • Für Treppen • Para escaleras



✓ Sécurise l'escalier

Makes stairs safer • Macht Treppen sicherer
Hace las escaleras más seguras

Lattes de sommier

Springing lath • Bettlatten • Lamas de somier



Ep. 8 mm

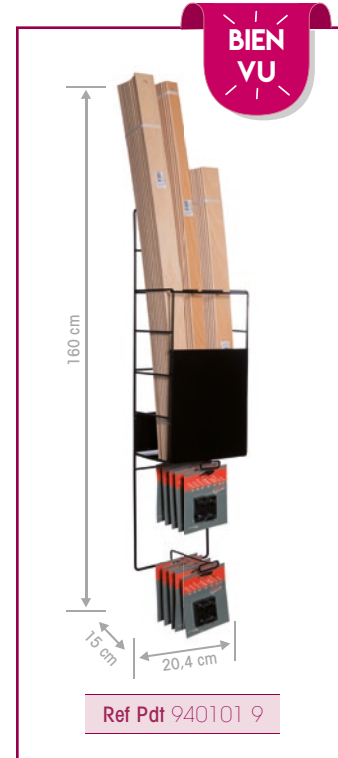

Ref Pdt 940101 9

l.	38 mm	53 mm	63 mm
Largeur du lit / Bed width / Bettbreite • Ancho de cama	Ref Pdt		
70 cm		A 741000 6	-
90 cm	C 741004 4	B 741001 3	E 740003 8
140 cm		D 741006 8	-



Embouts de latte plastique

Plastic tips • Plastik Kappen • Topes de plastico



Ep. 8 mm

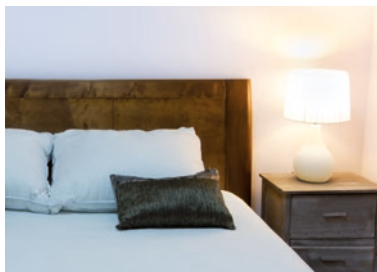

l.	38 mm	53 mm	63 mm
	Ref Pdt		
À clouer To nail • Zum Annageln • Para clavar	1 -	741002 0	-
À clipser To brooch • Zum Anklemmen • Con clips	3 -	741003 7	-
Double à clipser Doppel to brooch • Doble Zum Anklemmen • Con clips	5 741005 1	-	-



Tréteau Essentiel H

NOIR | U.C. x 4 | x 2 | 300 kg Maxi pour 2 tréteaux

- Matériau : métal
- Pieds démontables avec rangement intégré dans le cadre du tréteau

Removable legs with integrated storage in the trestle frame • Abnehmbare Beine mit integriertem Stauraum im Bockrahmen • Patas desmontables con almacenamiento integrado en el marco del caballete

AA ↑ 75 cm ↔ 75 cm ↗ 50 cm
 A ↓ 50 cm ↔ 75 cm ↗ 2,5 cm

Ref Pdt 640022 0

- ✓ Transport et rangement facilités
- ✓ Gain de place
- ✓ Pieds démontables sans outil
- ✓ Installation et démontage rapides
- ✓ Stabilité
- ✓ Extrémités tubulaires bouchées

Easy transport and storage • Einfache Transport und Lagerung • Transporte y almacenamiento fáciles - Save space • Spart Platz • Ahorra espacio - Removable legs without tools • Abnehmbare Füße ohne Werkzeug • Patas desmontables sin herramientas - Quick installation and release • schnelle Montage und Demontage • Instalación y desmontaje rápidos - Stable • Stabil • Estable - All tube ends with caps • Alle Rohrenden mit Kappen • Todos los extremos de los tubos con tapas.

Tréteau Helsinki



NOIR | U.C. x 4 | x 2 | 300 kg Maxi pour 2 tréteaux

- Matériau : métal
- Réglable en hauteur
- Pieds démontables avec rangement intégré dans le cadre du tréteau

Removable legs with integrated storage in the trestle frame • Abnehmbare Beine mit integriertem Stauraum im Bockrahmen • Patas desmontables con almacenamiento integrado en el marco del caballete

AA ↑ 78 - 108 cm ↔ 75 cm ↗ 50 cm
 A ↓ 53 cm ↔ 75 cm ↗ 2,5 cm

Ref Pdt 640027 5

- ✓ Transport et rangement facilités
- ✓ Gain de place
- ✓ Pieds démontables sans outil
- ✓ Réglable en hauteur
- ✓ Installation et démontage rapides
- ✓ Stabilité
- ✓ Extrémités tubulaires bouchées

Easy transport and storage • Einfache Transport und Lagerung • Transporte y almacenamiento fáciles - Save space • Spart Platz • Ahorra espacio - Removable legs without tools • Abnehmbare Füße ohne Werkzeug • Patas desmontables sin herramientas - Adjustable height • Höhenverstellbar • Altura ajustable - Quick installation and release • schnelle Montage und Demontage • Instalación y desmontaje rápidos - Stable • Stabil • Estable - All tube ends with caps • Alle Rohrenden mit Kappen • Todos los extremos de los tubos con tapas.

Tréteau Promalin métal

JAUNE | U.C. x 4 | x 2 | 350 kg Maxi pour 2 tréteaux

- Matériau : Métal
- Revêtement antidérapant sur la traverse supérieure
- Poignée plastique épaisse et souple

Plastic handle, thick and flexible Kunststoffgriff, dick und flexibel Mango de plástico grueso y flexible

Ref Pdt 640025 1

AA ↑ 78 cm ↔ 100 cm ↗ 50 cm
 A ↓ 6,5 cm ↔ 100 cm ↗ 10 cm

- ✓ Facile à plier et à transporter
- ✓ Pieds pliables avec rangement intégré dans le cadre du tréteau
- ✓ Traverse supérieure large pour plus de confort à l'usage

Easy to fold and carry • Leicht zu falten und zu tragen • Fácil de plegar y llevar - Removable legs with integrated storage in the trestle frame • Abnehmbare Beine mit integriertem Stauraum im Bockrahmen • Patas desmontables con almacenamiento integrado en el marco del caballete - Wide top bar for comfort in use • Breite Leiste oben für Komfort im Einsatz • Base superior ancha para mayor comodidad en uso.

Tréteau PRO kit

NOIR | U.C. x 4 | x 1 | 300 kg Maxi pour 2 tréteaux

- Matériau : métal
- Tréteau professionnel réglable en hauteur
- Charge lourde

Ref Pdt 640023 7

1 seul mouvement

AA ↑ 80 cm à 120 cm ↔ 68,5 cm ↗ 57 cm
 A ↓ 84 cm ↔ 68,5 cm ↗ 10 cm

- ✓ Robuste
- ✓ Réglable en hauteur
- ✓ Pliable pour être peu encombrant
- ✓ Rapport qualité/prix exceptionnel
- ✓ Ouverture et blocage simplifiés en un seul mouvement

Strong • Robust • Robusto - Adjustable height • Höhenverstellbar • Altura ajustable - Foldable therefore takes up little space • Faltbar nimmt daher wenig Platz • Plegable, por lo tanto ocupa poco espacio - Exceptional price / quality ratio • Außergewöhnliches Preis / Leistungsverhältnis • Relación calidad / precio excepcional - Simplified implementation in one movement • Vereinfachte Umsetzung in einer Bewegung • Aplicación simplificada con un solo movimiento.



Tréteau Classic +

NOIR | UNIT x 10 | x 1 | 100 kg Maxi pour 2 tréteaux

Matériau : métal

Ref Pdt 640021 3

↑ 75 cm → 64 cm ↗ 47 cm

↑ 80 cm → 64 cm ↗ 4 cm



- ✓ Excellent rapport qualité/prix
- ✓ Système de compas innovant pour une sécurité accrue
- ✓ Qualité renforcée : épaisseur du compas et diamètre du tube
- ✓ Pliable pour être peu encombrant

Excellent price / quality ratio • Sehr gutes Preis / Leistungsverhältnis • Excelente relación calidad / precio.
Compass system for added security • Compass-System für zusätzliche Sicherheit • Sistema de compas para mayor seguridad - Enhanced-Quality: hinge thickness and tube diameter • Verbesserte Qualität: Scharnierdicke und Rohrdurchmesser • Calidad mejorada: espesor de la bisagra y diámetro del tubo - Foldable therefore takes up little space • Faltpbar nimmt daher wenig Platz • Plegable, por lo tanto ocupa poco espacio.

Artisan Galva

GALVANISÉ | UNIT x 4 | x 1 | 300 kg Maxi pour 2 tréteaux

- Matériau : acier galvanisé
- Réglable en hauteur

Adjustable height • Höhenverstellbar
Altura ajustable

Ref Pdt 640024 4

↑ 80 cm à 130 cm → 70 cm ↗ 47 cm

↑ 80 cm → 70 cm ↗ 13 cm



- ✓ De type pro/apptitude chantier
- ✓ Robuste
- ✓ Pliable pour être peu encombrant

Professional type. For construction sites • Profi-Ausführung. Für Baustellen • Tipo profesional. Para obras de construcción - Robust and durable • Robust und langlebig • Robusto y duradero - Foldable therefore takes up little space • Faltpbar nimmt daher wenig Platz • Plegable, por lo tanto ocupa poco espacio.



 Déplié Unfolded
Aufgeklappt • Abierto

 Plié Folded
Gefaltet • Plegado

▶ ACCESSOIRES & OUTILLAGE | BARRIÈRES POUR ANIMAUX



Barrières pour animaux

Pet gates
Tiergitter
Puerta para animales



Bois
Wood
Holz
Madera



U.C. x 5

U.C. PGM x 3

Inadaptées aux enfants

Not adapted to children • Passt nicht für Kindern
No aptos para niños

Mara



		Réf Pdt
H.	95 cm	742043 2
l.	73 / 84 cm	
Extension 10 cm		742044 9

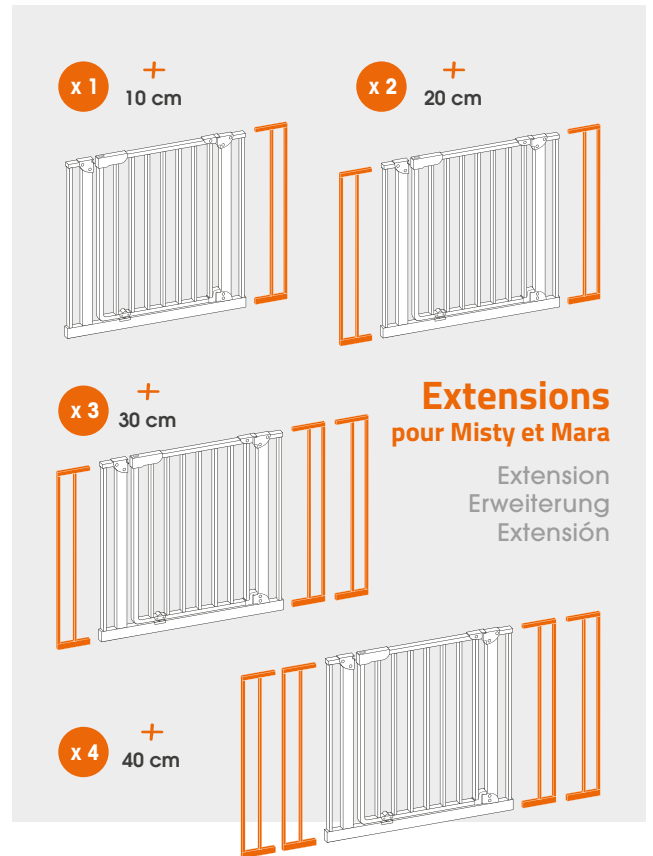

Misty



		Réf Pdt
H.	76 cm	742041 8
l.	73 / 84 cm	
Extension 10 cm		742042 5

Kenny



		Réf Pdt
H.	105 cm	742040 1
l.	87 / 153 cm	

Médor



		Réf Pdt
H.	105 cm	742039 5
l.	67 / 113 cm	

Stop'Fix XX Tall



		Réf Pdt
H.	120 cm	742051 7
l.	60 / 200 cm	



Mini box fermetures animaux

Mini Box display for animal gates
Mini Box für Tiergitter
Mini Box de vallas para animales



	Stop'fix	Stop'Max	Press'fix
UNIT	x 40	x 25	x 30
Réf Pdt			
940071 5			

Press'Fix



Stop' fix



Stop' Max



	Stop'fix xx Tall Pivotante	Stop'fix Pivotante	Stop'Max Pivotante	Press'fix À pression	Médor	Kenny	Misty	Mara
	Pivoting Holzgitter Pivotante	Pivoting Holzgitter Pivotante	Pivoting Holzgitter Pivotante	Pressure Drückgitter A presión	Pivoting Holzgitter Pivotante	Pivoting Holzgitter Pivotante	Pivoting Holzgitter Pivotante	Pivoting Holzgitter Pivotante
H.	120 cm	83 cm			105 cm	76 cm	95 cm	
l.	60 / 200 cm	60 / 110 cm	60 / 230 cm	65 / 104 cm	67 / 113 cm	87 / 153 cm	73 / 84 cm	
Décor	Réf Pdt							
Blanc White • Weiss • Blanco	-	742001 2	-	-	-	-	-	-
Bois Wood • Holz • Madera	742051 7	742000 5	742011 1	742004 3	-	-	-	-
Métal Metal • Metaal • Metálica	-	-	-	-	742039 5	742040 1	742041 8	742043 2

► SÉCURITÉ | BARRIÈRES DE SÉCURITÉ ENFANTS

Pivotante



Barrières de sécurité enfants pivotantes

Pivoting children safety gates
Schwenkbare Kindersicherheitsgittern
Pivotante vallas de seguridad para niños



- Métal
Metal • Metall
- Bois
Wood • Holz • Madera

Fixation avec perçage

With drilling • Zum Schrauben • Con perforación

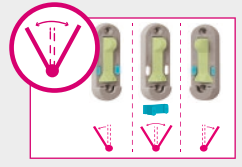
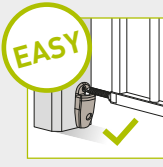
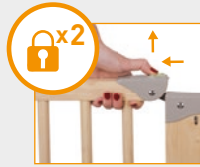

Léa

NOUVEAUTÉ 2021

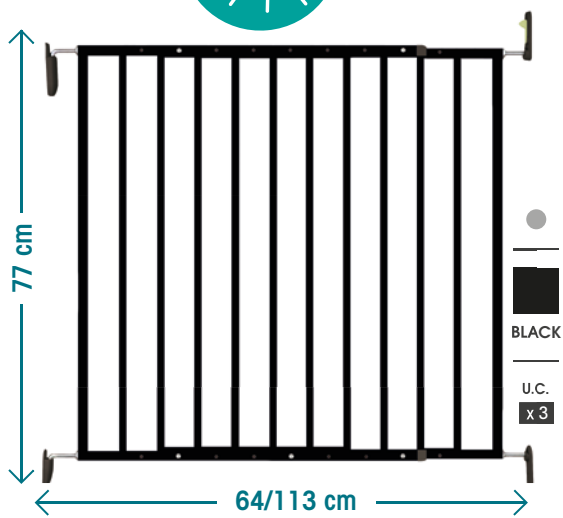

Ref Pdt	800042 8
Kit quincaillerie Hardware ki • Kleisenwaren • Kit fijaciones	630060 5

Victoria



Ref Pdt	742028 9
Kit quincaillerie Hardware ki • Kleisenwaren • Kit fijaciones	630060 5

Vogue

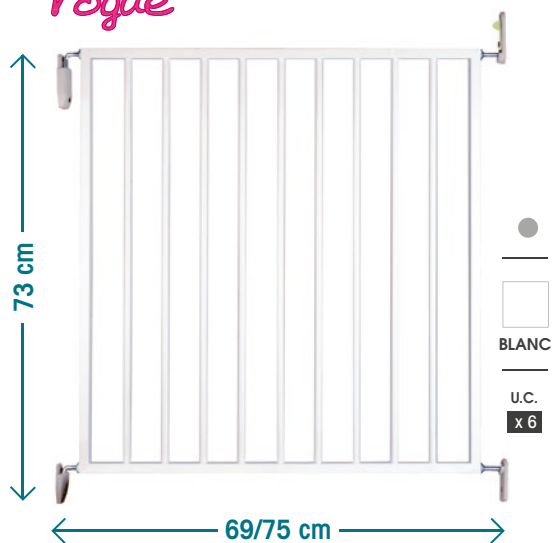

Ref Pdt	742029 6
Kit quincaillerie Hardware ki • Kleisenwaren • Kit fijaciones	630061 2

Prune

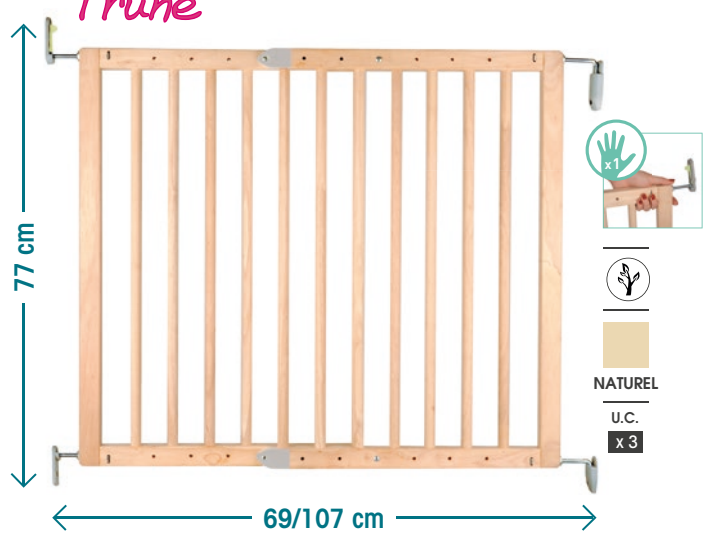

Ref Pdt	742030 2
Kit quincaillerie Hardware ki • Kleisenwaren • Kit fijaciones	630062 9



Nidalys, la marque de sécurité enfant de Nordlinger Pro !

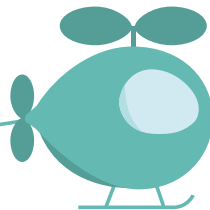

Barrières de sécurité enfants amovibles

Pull & hold children safety gates
Ziehen & halten Kindersicherheitsgittern
Elevar & quitar vallas de seguridad para niños



Lila

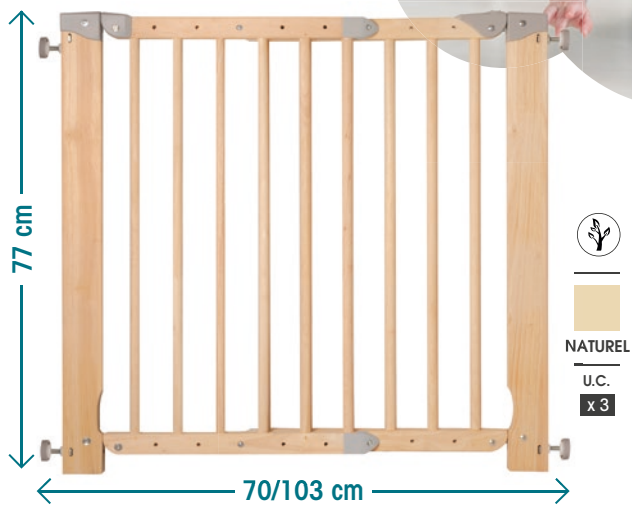

Ref Pdt	630053 7
Kit quincaillerie Hardware ki • Kleineisenwaren • Kit fijaciones	630064 3

À pression
Pressure mounted • Zum Drücken • Presión

CONFORME A LA NORME
NORME NF EN 1930
02 / 2019

PEFC 10-31-3387

x2 x1

Oléane 7



Ref Pdt	630049 0
Kit quincaillerie Hardware ki • Kleineisenwaren • Kit fijaciones	630063 6

Oléane 8

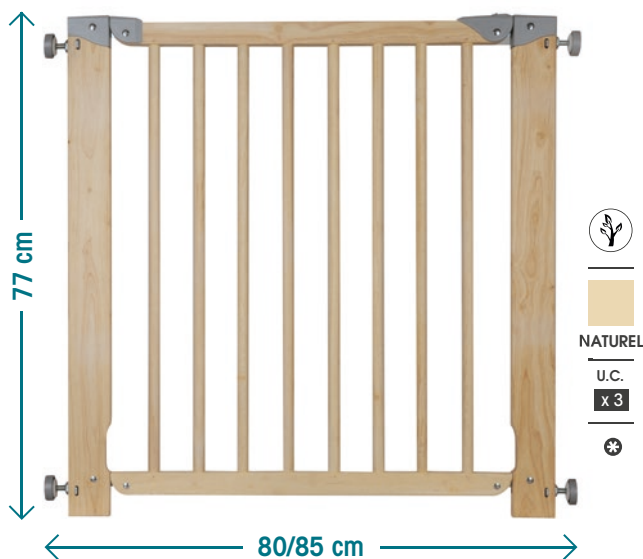

Ref Pdt	630050 6
Kit quincaillerie Hardware ki • Kleineisenwaren • Kit fijaciones	630063 6

Jusqu'à épuisement du stock

► SÉCURITÉ | BARRIÈRES DE SÉCURITÉ ENFANTS



Barrières de sécurité enfants portillons

Central Gate children safety gates • Zentrale Tür kindersicherheitsgittern • Puerta Central vallas de seguridad para niños



● Métal
Metal
Metall

Portillon



À pression

Pressure mounted • Zum Drücken • Presión



Enzo

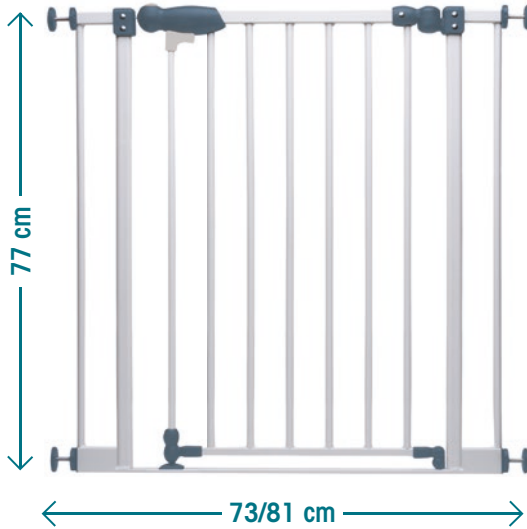

Barre de sol ultra plate !

Flat step-over bar • Vlakke drempel

●
BLANC
U.C.
x 3



Barrière Enzo vendue sous emballage carton

Ref Pdt		800041 1
Kit quincaillerie	Hardware ki • Kleineisenwaren • Kit fijaciones	630052 0
Extension blanc Extensions Erweiterung Extension	Extension A 8 cm	630046 9
	Extension B 16 cm	630047 6
	Extension C 20 cm	630048 3

Besoin d'aide ?

Flashez le code ci-contre pour accéder au guide d'aide au choix de la barrière.



Aalto



●
BLANC
U.C.
x 3

Sofia

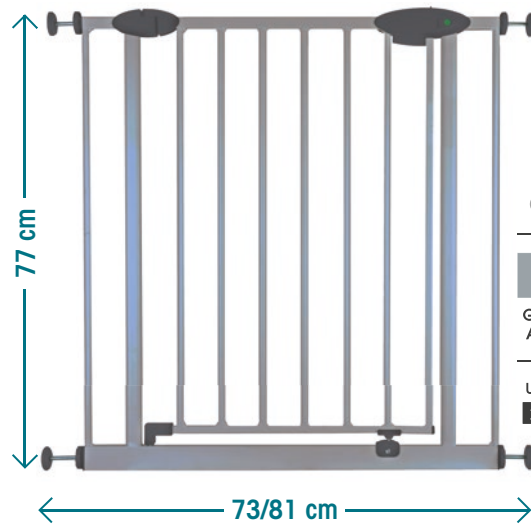

●
GRIS ALU
U.C.
x 3

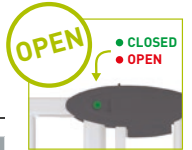

Ref Pdt		630045 2
Kit quincaillerie	Hardware ki • Kleineisenwaren • Kit fijaciones	630052 0
Extension blanc Extensions • Erweiterung • Extension	Extension A 8 cm	630046 9
	Extension B 16 cm	630047 6
	Extension C 20 cm	630048 3

Ref Pdt		630051 3
Kit quincaillerie	Hardware ki • Kleineisenwaren • Kit fijaciones	630065 0
Extension gris alu Extensions • Erweiterung • Extension	Extension A 8 cm	630054 4
	Extension B 16 cm	630055 1
	Extension C 20 cm	630056 8

Barrière pare feu / multifonctions

Fire guard gate • Kaminschutzgitter • Valla cortafuego



Ref Pdt 742022 7

Conforme aux exigences de sécurité



Pour protéger l'enfant à la maison

To protect children at home • Um die Kindern ins Hause Schützen • Para proteger los niños en la vivienda

U.C.



Cale-porte x1

Door Stop • Türstopper •
Tope de puerta



Ref Pdt 742064 7

Cache prises avec clé x6 + 1 clé

Socket safety cover with key •
Cache mit Schlüssel übernommen •
Caché tomada con llave



Ref Pdt 742065 4

Protection coins de table x4

Protection for table corners •
Schützung für Tafelecken •
Protege-esquinas de mesa



Ref Pdt 742058 6

Bloque tiroir x2

Drawer safety catch •
Schubladensperre • Cerradura del cajón

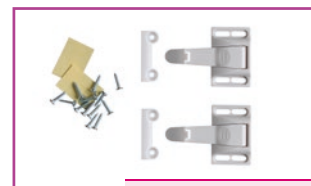

Ref Pdt 742062 3

Bloque-placards souples x2

Flexible cupboard safety catch •
Blöcke-flexible Schränke • Bloques-
armarios flexibles



Ref Pdt 742060 9

Bloque-placards d'angles x2

Corner cupboard safety catch •
Block-Ecke Schränke • Armarios
de esquina de bloque



Ref Pdt 742059 3

Bloque-placards rigide x2

Rigid cupboard safety catch •
Starre Schrankblock • Bloque
de armario rígido



Ref Pdt 742061 6

Bouton de sécurité four /gazinière x2

Cooker button safety cover • Ofen /
Gasherd Sicherheitstaste • Botón de
seguridad de la estufa / horno de gas



Ref Pdt 742063 0



► SÉCURITÉ | BARRIÈRES DE SÉCURITÉ ENFANTS



Barrières de lit

Bedguard • Bettgitter
Valla de cama



BOIS
NATUREL



BLANC



PEFC
10-31-3387



NOUVEAU
SÉCURITÉ
RENFORCÉE,
MAINTENUE AU
MATELAS



90 cm Finition Bois Naturel	u.c. x 5	Ref Pdt 742091 3
120 cm Finition Bois Naturel	u.c. x 4	Ref Pdt 742092 0
120 cm Finition Blanc	u.c. x 4	Ref Pdt 742093 7



Bébé grandit ?

*Transformer
sa barrière
de lit ?*

IDÉE DÉCO



Adaptateur pour escalier

To close staircases • Om trappen te sluiten • Para cerrar escaleras



Ref Pdt 742021 0



Adaptateur pour
fermeture escalier



AIDES À LA VENTE

Sales helps • Verkaufshilfen • Soportes de venta

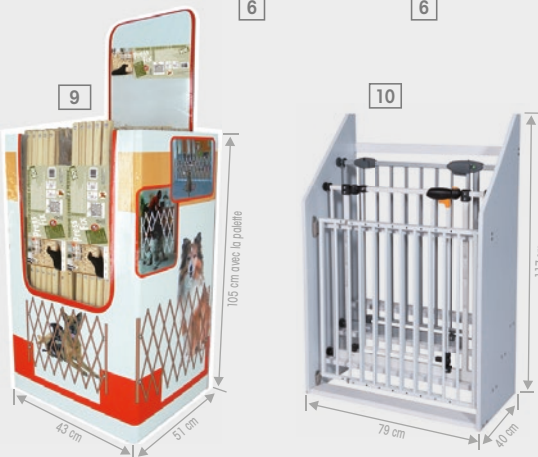

	CAPACITY	Ep. x l. x L.	Ref Pdt	
1	Cross filaire 6 broches 6 Hooks display unit • 6 Brochen Präsenter Expositor 6 pinchos		20 x 5,5 x 125 cm	940068 5
	Cross filaire 6 broches + ILV thermo (skin chant)	42		
	Cross filaire 6 broches + ILV adh. (skin chant)	48		
2	Dévidoir vertical G.M. Display X.L. • Präsenter X.L. • Expositor X.L.		20 x 17 x 112 cm	940019 7
	Dévidoir vertical G.M. + ILV thermo			
	Dévidoir vertical G.M. + ILV adh. Dévidoir vertical G.M. + ILV mastiplast	96		
3	Présentoir Smart Profile + profils + stickers ronds	106	51,5 x 37 x 148 cm	940187 3
4	Présentoir 8 broches 8 Hooks display unit 8 Brochen • Expositor 8 pinchos		30 x 42 x 48 cm	940003 6
5	Présentoir filaire clips (boîtes clips)	22	10 x 22 x 92 cm	970016 2
6	Présentoir filaire lattes (lattes) (embouts de lattes) (placflex) (profilés alu)	30	20,4 x 15 x 153 cm	940072 2
		10		
		6		
		60		
7	Cross filaire 4 broches		20 x 5,5 x 127 cm	940105 7
	Cross filaire 4 broches + ILV taquets (skin taquet)	24		
8	Box "clips" : 3mm (250) 3mm (100) autres	250	51 x 43 x 105 cm	940005 0
		500		
		175		
9	Mini box fermetures animaux (press fix) (stop fix) (stop max)	30	43 x 51 x 105 cm	940071 5
		40		
		25		
10	Présentoir escalier "barrières"	4	79 x 40 x 117 cm	940110 1
11	Mini box barrière enfants (page suivante)		75 x 60 x 90 cm	940070 8
12	Présentoir plinthes	240	89 x 70 x 237 cm	940155 2
13	Présentoir plaque composite	50	86 x 50 x 150 cm	940157 6



AIDES À LA VENTE

Sales helps • Verkaufshilfen • Soportes de venta

Les stickers

	ℓ. x H.	Ref Pdt
Sticker Placfix	17 x 25 cm	940053 1
Sticker Profplast		940050 0
Sticker Mastiplast	17 x 25 cm	940020 3
Sticker Meladhesiv'		940067 8
Sticker Melafix		940066 1
Sticker Prof'Alu		940028 9
Sticker Placflex		940104 0
Sticker Profil XSC - XSB		940107 1
Sticker Clips		940029 6
Plinthes plastique	17 x 25 cm	940132 3
	9 x 30 cm	940133 0
Sticker Lattes pour filaire	17 x 25 cm	940073 9
Sticker Taquets		940102 6
Sticker Rapid'Fix		940103 3
Barrière de lit	30 x 10 cm	940032 6
Stop'Max	30 x 10 cm	940079 1
Press'Fix	30 x 10 cm	940080 7
Stop'Fix		940081 4
Placflex	30 x 30 cm	940122 4
Plaque Composite Alu	10 x 30 cm	940152 1
ILV pread	17 x 25 cm	940135 4
ILV cannage		940136 1
ILV Profil U Transparent		940137 8
ILV Nez de Cloison		940181 1
ILV Jambage de Cuisine		940180 4
Pread Carré		940135 4
Profil Finition de Crédençe		940139 2
Barrière Aalto		940159 0
Barrière Lila		940160 6
Barrière Oléane 7		940161 3
Barrière Prune	10 x 30 cm	940163 7
Barrière Sofia		940164 4
Barrière Victoria		940166 8
Barrière Vogue		940167 5



Mini box barrières de sécurité enfants

Mini box display for baby safety gates
 Mini box für kinder sicherheitsgitter
 Mini box de vallas de seguridad para niños



	Victoria	Vogue	Prune	Oléane 7	Lila	Aalto	Sofia	Enzo
CAPACITY	x 15	x 30	x 15	x 15	x 12	x 12	x 12	x 12
Ref Pdt	940158 3							

Les nuanciers

The colour schemes • Die Farben • Los muestrarios

	Ep.	Ref Pdt
Melanor	0,3 mm	940022 7
Nordex	0,8 mm	940023 4
Nordex	2 mm	940024 1
Bois Rolchant	-	970025 8
Alese	-	940027 2
QSapin	-	940026 5
Mélaminé grandes largeurs	-	940141 5



CS n°20001 Vignolles • 16300 Barbezieux-Saint-Hilaire • France

France tél : 05 45 78 19 99 • fax : 05 45 78 28 80

International tél : 0033 545 787 957 • fax : 0033 545 782 880

contact@nordlinger-pro.com

www.nordlinger-pro.com



N°TVA : FR83 485310262 / RCS Angoulême : 485310262

SIRET : 48531026200012

© Crédits photos : iStock - Fotolia - Photographmd - Ostap25
Shutterstock - Freepick - Mickaël Tollemer.

Conception © Maia www.maia-creation.com